

# Operation Manual

---

Manual No: 504032100002-EN

Manual Version: A

November 2024

Translated version

**AB22J Plus (AB22J Plus/AB710J Plus) 0403200100 to current**

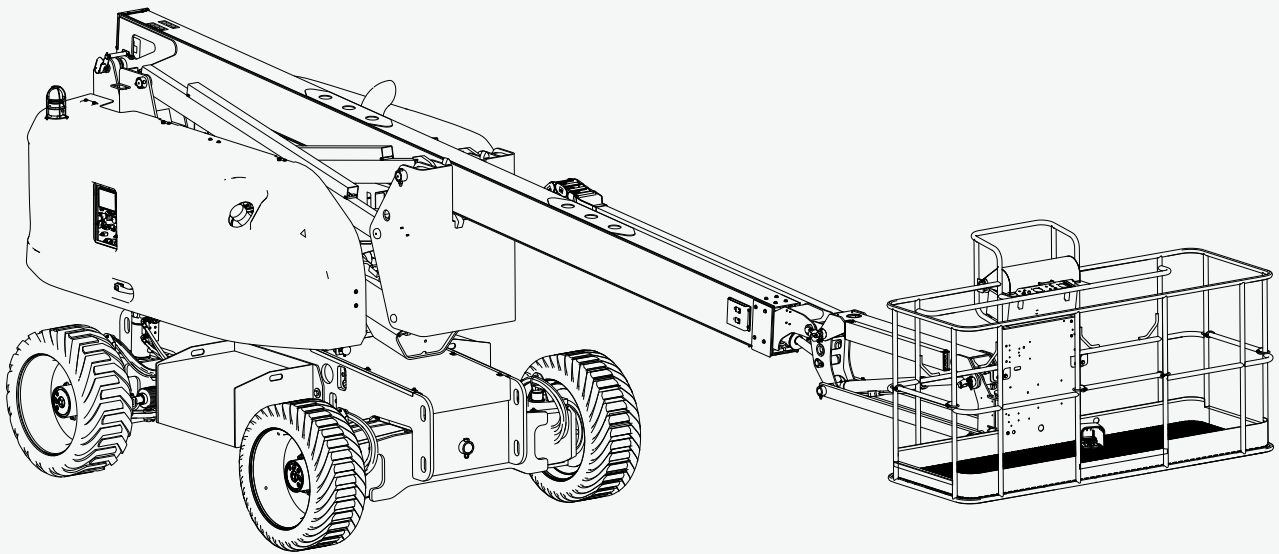

**CE GB AS/NZS EAC**

**SINOBOOM**





## **WARNING**

**Operating, servicing and maintaining this vehicle or equipment can expose you to chemicals including engine exhaust, carbon monoxide, phthalates and lead, which are known to cause cancer and birth defects or other reproductive harm. To minimize exposure and avoid breathing exhaust, do not idle the engine except as necessary, service your vehicle or equipment in a well-ventilated area and wear gloves or wash your hands frequently when servicing. For more information, go to: [www.P65warnings.ca.gov](http://www.P65warnings.ca.gov).**

**For disposal, please comply with local regulations.**

**SINOBOOM**



**星邦智能**

**星邦**

All of the above are registered trademarks of **Hunan Sinoboom Intelligent Equipment Co., Ltd.**

## **Contact us:**

**Website:** [www.sinoboom.com.cn](http://www.sinoboom.com.cn) (China) / [www.sinoboom.com](http://www.sinoboom.com) (except China)

**Sales Tel:** 400-601-5828 (China) / 0086-0731-87116222 (except China)

**Service Tel:** 400-608-1289 (China) / 0086-0731-87116333 (except China)

**E-mail:** [info@sinoboom.com](mailto:info@sinoboom.com) (China) / [sales@sinoboom.com](mailto:sales@sinoboom.com) (except China)

**Address:** No.128, East Jinzhou Avenue, Ningxiang High-tech Industrial Park, Changsha, Hunan, China

**Postal code:** 410600

**Copyright**©Hunan Sinoboom Intelligent Equipment Co., Ltd.

Hunan Sinoboom Intelligent Equipment Co., Ltd. retains the right of final interpretation of the manual.

# To Users

Thank you for choosing and using the machinery of **Hunan Sinoboom Intelligent Equipment Co., Ltd.**

Use this machine only to transport tools to work locations and for performing tasks on the work platform. Only authorized personnel who have received appropriate MEWP training may operate this machine. Before using the machine, carefully read and fully understand this manual and strictly follow its relevant instructions. Different countries, regions, or governments may have equipment relevant regulations that conflict with this manual. The stricter safety regulations should be followed. Our company will not be liable for any adverse consequences arising from the failure to operate and use the machine in accordance with this manual or other relevant regulations.

This manual provides necessary safety precautions and operation instructions for users. This manual covers the basic configuration information of one or more models. Please refer to the information applicable to your machine model. Treat this manual as an integral part of the machine and keep it with the machine at all times. This manual may not be copied, distributed, sold, or altered without written permission from Sinoboom.

Due to continuous improvement and upgrading of product design and different product models covered, some charts and textual content in the manual may be not applicable to your machine. Our company reserves the right to revise the contents of this manual due to technological improvements. Changes will be made without prior notice. Contact Sinoboom to obtain the most current version of the manual.

Please go to [www.sinoboom.com](http://www.sinoboom.com) to download your desired Operation Manual, Maintenance Manual and Parts Manual.

If you have any questions, contact **Hunan Sinoboom Intelligent Equipment Co., Ltd.**



# Applicable Models

The manual applies to the following models and serial numbers:

Model	Metric Trade Name	Imperial Trade Name	Serial No.
AB22J Plus	AB22J Plus	AB710J Plus	0403200100 to current

**Note:**

- Check the machine model and serial number on the machine nameplate. The location of the nameplate can be found in the **Decals Diagram** section of the Operation Manual.
- Product model numbers are indicated on the nameplates to distinguish products with different main technical parameters.
- Product trade names (product commercial codes) are used for marketing purposes and machine decals for the differentiation of products with different main technical parameters. Product trade names are categorized as metric and imperial trade names: metric trade names are applicable to regions/countries using the metric system or as specifically requested by customers; imperial trade names are applicable to regions/countries using the imperial system or as specifically requested by customers.



# CONTENTS

<b>1</b>	<b>Safety Warning Symbols and Signs .....</b>	<b>1</b>
<b>2</b>	<b>Important Safety Rules .....</b>	<b>5</b>
2.1	General .....	5
2.2	Preparing for Operation .....	5
2.3	Operation Safety .....	6
2.4	Towing, Hauling and Lifting Safety .....	13
2.5	Maintenance Safety .....	14
<b>3</b>	<b>Responsibilities of Relevant Parties .....</b>	<b>19</b>
3.1	Owner's (or Lessor's) Responsibilities .....	19
3.2	Employer's Responsibilities .....	19
3.3	Trainer's Responsibilities .....	19
3.4	User's Responsibilities .....	19
<b>4</b>	<b>Technical Parameters .....</b>	<b>21</b>
4.1	Machine Specifications .....	21
4.2	Function Speed .....	23
<b>5</b>	<b>Pre-operation Inspection</b>	<b>25</b>
5.1	Basic Machine Components .....	25
5.2	Machine Positions .....	26
5.3	Pre-start Inspection .....	26
5.4	Functional Test .....	27
<b>6</b>	<b>Controllers and Indicators .....</b>	<b>29</b>
6.1	Turntable Controller .....	29
6.2	Turntable Display .....	31
6.3	Platform Controller .....	33
6.4	Platform Display Screen .....	35
<b>7</b>	<b>Operation Instructions .....</b>	<b>37</b>
7.1	General .....	37
7.2	Working Envelope Diagram .....	38
7.3	Common Alarm Messages .....	38
7.4	Stability .....	39
7.5	Gradeability .....	42
7.6	Engine Operation .....	42
7.7	Exhaust After-treatment System-If Equipped .....	43
	EAT Regeneration Process .....	43
	Cancel EAT Regeneration Process ..	43
	EAT Regeneration Failed .....	43
7.8	Turntable Slewing .....	43
7.9	Traveling .....	44
	Travel on Slopes .....	44
7.10	Boom Movements .....	45
7.11	Platform Movements .....	46
7.12	Hydraulic generator (if equipped) .....	47
7.13	Auxiliary Power .....	47
7.14	Turning Off and Stopping .....	47
7.15	Transport and Lifting .....	48
7.16	Storage .....	49
<b>8</b>	<b>Emergency Procedures ..</b>	<b>53</b>
8.1	Reporting Accidents .....	53
8.2	Emergency Operation .....	53
8.3	Emergency Lowering .....	53
8.4	Emergency Towing .....	54
8.5	Override Operation with an Overloaded Platform .....	54
8.6	Operator Protective Operation ..	55
<b>9</b>	<b>Decals Diagram .....</b>	<b>57</b>

<b>10</b>	<b>Maintenance</b>	<b>61</b>
10.1	Lubrication	61
10.2	Oil Specifications	62
10.3	Tire Assembly	63
	Check Wheel Nuts	64
	Replacement Requirements	64
	Replace Tire and Wheel Assembly	65
10.4	Inspection and Preventive	
	Maintenance Schedule	65
	Pre-delivery Inspection	65
	Pre-operation Inspection	65
	Regular Inspections	65
	Annual Inspection	66
	Preventive Maintenance	66
	Responsible Persons and Quali-	
	fications for Performing Inspection	
	and Maintenance	66
	Inspection and Preventive Mainte-	
	nance Schedule	66

# 1 SAFETY WARNING SYMBOLS AND SIGNS

The safety warning symbols used on the machine and in the manuals have the following meanings:



Safety warning symbol. This symbol is used to alert you to potential hazards. Observe all safety instructions following a symbol to avoid possible injuries.

## DANGER

Indicates an imminently hazardous situation that, if not avoided, will result in death or serious injury.

## WARNING

Indicates an imminently hazardous situation that, if not avoided, could result in death or serious injury or serious damage to the machine.

















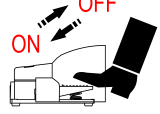

## CAUTION



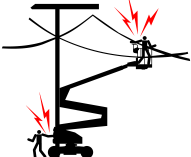
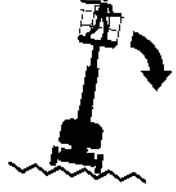

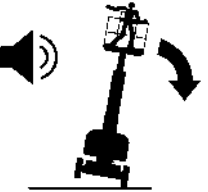

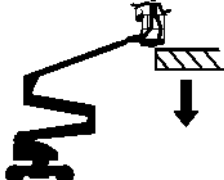





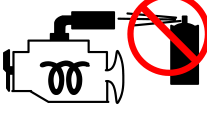







Indicates an imminently hazardous situation that, if not avoided, could result in minor or moderate injury or machine damage.

## NOTICE

*Indicates information directly or indirectly related to personal safety, machine damage, or property loss.*

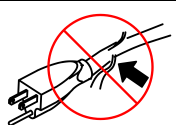
The safety signs used on the machine and in the manuals have the following meanings:

 Refer to the Maintenance Manual	 Anchor point only for 1 person	 Wind speed	 Chemical burns hazard	 Wedge the wheel
 Refer to the Operation Manual	 Add lubricant	 Crushing hazard – safety shoes required	 Danger of hot, high-pressure fluid spray	 Wind
 Noise level	 Burn hazard	 Keep a safe distance from high temperatures	 Pull out – ON Press – OFF	 Alarm sounding
 Depress – ON Release – OFF	 Hydraulic oil level low	 Hydraulic oil level high	 Temperature	 Replace with tires of the same specification
 Only qualified maintenance personnel may access the compartment	 Electrocution hazard on platform	 Electrocution hazard on the ground and platform	 Tipping hazard – avoid uneven ground	 Tipping hazard – avoid uneven ground
 Tipping hazard – never use machine in strong, gusty winds	 Tipping hazard – never use machine in strong, gusty winds	 Tipping hazard – never push or pull objects outside the platform	 Tipping hazard – never suspend objects from the platform	 Tipping hazard – never place ladders and scaffolding on the platform
				

Collision hazard – keep the platform clear of obstacles below when lowering the platform	Collision hazard – keep head clear of overhead obstacles when raising platform	Crushing hazard – keep hands clear from overhead obstacles when raising platform	Fall hazard – never climb on platform guardrails	Fall hazard – never climb on the boom
 Keep clear from the rotating platform	 Engine preheating explosion hazard	 Never use ether or other starting additives for machines equipped with a glow plug	 Fuel explosion hazard	 Wear protective clothing and safety goggles
 Only qualified maintenance personnel may perform maintenance work	 Lateral force	 Electrocution hazard	 Battery explosion hazard	 No smoking or open flames/sparks
 No smoking or open flames/sparks	 Lifting point	 Lashing point	 Tire ground pressure	 Hydraulic oil filler
 Platform load capacity	 Do not use damaged power cords	 Tool or weight	 Fast/high speed	 Slow/low speed
 Horn				

**This Page Intentionally Left Blank**

# 2 IMPORTANT SAFETY RULES

## 2.1 GENERAL

This chapter briefly describes the precautions that must be followed for safe and proper operation and maintenance of this machine. To ensure safe use and proper operation of the machine, the operator must perform routine maintenance on the machine in accordance with the Operation Manual and Maintenance Manual. In addition, the machine must be regularly maintained and serviced by a qualified service technician according to the instructions provided in the Maintenance Manual.

Familiarize yourself with the local regulations concerning Mobile Elevated Work Platforms (MEWPs) and related operations. The rules for equipment operation from different countries, regions, or governments may conflict with this manual, so the stricter safety operation rules should be followed. If you have any questions about safety, training, inspection, maintenance, purposes and operation of the machine, please contact Hunan Sinoboom Intelligent Equipment Co., Ltd.

Sinoboom cannot foresee all the potential hazards related to this machine, so all parties involved should place high importance on safety issues.

### WARNING

**Failure to follow the operating instructions and safety rules in this manual may result in machine damage, property loss, or personal injury.**

## 2.2 PREPARING FOR OPERATION

### Operator's Training and Knowledge Requirements

Before operating this machine, read, understand, and comply with all applicable regulations and requirements of employers, local authorities, and the government related to equipment use.

Before operating this machine, you should read and fully understand this manual, undergo professional training based on this Operation Manual, and only operate this machine independently after acquiring the qualification for proficient operation. The training content should include, but not be limited to, the following topics:

- Warnings, operating instructions, and the Operation Manual on the machine.

- Pre-start test
- Factors affecting the stability of the machine
- Common hazards and how to avoid them
- Workplace Inspection
- Functions and related knowledge of all controls, including emergency controls
- Use of personal protective equipment appropriate to the work task, workplace, and environment
- Safe operation
- Transport
- How to prevent unauthorized use

### Workplace Inspection

Before and during the operation of the machine, users must pay attention to the hazards and take preventive measures to avoid hazards in the work area. Without the written permission of Hunan Sinoboom Intelligent Equipment Co., Ltd., this machine shall not be used in the following areas or conditions:

- Steep slopes or caves
- Ground with protrusions, obstacles, or debris
- Insecure or slippery surfaces
- Surfaces not sufficient to support the machine (machine weight + load weight)
- Trucks, trailers, rail cars, ships, or other equipments
- Dangerous locations
- Places with overhead electric wires, cranes, or other potential obstacles
- In gusty and/or strong wind conditions, or lightning
- Unauthorized persons
- Other areas where unsafe conditions may occur

### Machine Inspection

Make sure to complete all checks in strict accordance with the steps in the **Pre-operation Inspection** section of this manual before operating the machine:

- **Pre-start test**: Ensure that no components are loose/loosening, missing or altered. Components must be securely fixed, without visible damage, leakage, or excessive wear, etc., all parts must be in their original locations and operating position; make sure that all fluid levels, battery level, etc. are appropriate; ensure that maintenance work has been completed

in accordance with the requirements specified in the Maintenance Manual.

- **Decals inspection** : Ensure that no decals and nameplates are missing and/or damaged; decals must be clearly visible.
- **Functional test** : Make sure that all functions of the machine are working properly.





## WARNING

**It is forbidden to alter or modify the machine without the written permission of Hunan Sinoboom Intelligent Equipment Co., Ltd.**

## 2.3 OPERATION SAFETY

General

 **WARNING**





- This machine shall only be used to transport tools to work locations and for performing tasks on the work platform, and should not be used for other purposes.
- Operators should use personal fall protection equipment (PFPE) while operating the machine. If the use of PFPE by persons on the platform is required in the workplace or user rules, the PFPE shall be inspected and used in accordance with the PFPE manufacturer’s instructions and applicable government requirements.
- The operator must devote their full attention to their work during the operation of the machine. The use of mobile phones, wireless communication devices, etc. may distract the operator and affect the safe operation of the machine, so the operator should completely stop the machine before using such devices.
- Remove all accessories (rings, watches and others) before operating the machine, do not wear loose clothing, and do not let long hair hang loosely.
- Individuals who have consumed alcohol or taken medication, who are overly fatigued or mentally distressed, who suffer from health conditions such as heart disease, high blood pressure, epilepsy, etc., individuals with a fear of heights or who feel unwell are prohibited from operating the machine.
- It is prohibited to use the power supply of the machine to power external electrical devices.
- Do not operate a damaged or malfunctioning machine. In case of any failure, stop the machine immediately, label the machine appropriately, and contact the manufacturer or relevant department.
- Never disassemble, modify or retrofit the machine or its parts.

 **WARNING**

- Never disable any safety devices of the machine.
- Never place objects on the platform guardrails.
- Never push the control switch or joystick forcefully through the neutral position directly into the opposite direction. Before pushing the switch to the next function position, move it back to the neutral position and stop, and then move it with slow and uniform force to perform the next function.
- Except in case of emergency, it is forbidden to perform operations from the ground if any person is still on the platform.
- When there are two or more people on the platform, all operation of the machine must be conducted by the operator.
- Always operate the machine in well-ventilated conditions to avoid carbon monoxide or nitrogen oxide poisoning.
- Before leaving the machine, the platform should be completely lowered and all power should be shut off.

## Electrocution Hazard

⚠ **WARNING**

- This machine is not insulated and is not equipped with electric shock or insulation protection features.
- Do not use this machine during thunderstorms or heavy rain. Should you encounter thunderstorms or heavy rain while operating the machine, immediately lower the platform completely to a safe and stable position, and disconnect all power sources so as to avoid personal injury or machine damage.
- Comply with the national or regional provisions covering minimum safe distance from live conductors. In absence of such provisions, comply with the specifications in the table below to keep a minimum safe distance from power lines, electrical equipment or any live (bare or insulated) components. The minimum safe distance must take into account factors such as machine movement and the swinging or sagging of power lines.
- If an insulating partition rated for the voltage of the power lines is installed, the minimum safe distance can be reduced. Such partitions may not be part of the machine or fixed on the machine. The reduction in the minimum safe distance due to insulating partitions must comply with the relevant national or local regulations.
- Do not use the machine as a ground wire during welding and polishing operations.

Table 2-1 Minimum Safe Distance

Voltage (Phase to Phase, kV)	Minimum Safe Distance
0 - 50	3.05 m (10 ft)
50 - 200	4.60 m (15 ft)
200 - 350	6.10 m (20 ft)
350 - 500	7.62 m (25 ft)

Table 2-1 Minimum Safe Distance (continued)





Voltage (Phase to Phase, kV)	Minimum Safe Distance
500 - 750	10.67 m (35 ft)
750 - 1000	13.725 m (45 ft)

⚠ **DANGER**

Do not operate the machine or transport personnel with the machine within access-restricted areas with live electrical equipment.

## Tripping and Fall Hazards

⚠ **WARNING**

- Before operating the machine, make sure that the platform guardrails are properly installed and that the platform gates are closed and properly secured.
- Operators on the platform must wear the safety belt properly and secure the safety belt to the specified anchorage point with the hook. Each anchorage point should only be used by one person.
- Exercise extreme caution when entering and exiting the platform. Use only the platform gate for access and never use the boom for entry or exit. Before entering and exiting the platform, make sure the platform is fully lowered. When entering and exiting the platform, face the platform and maintain three points of contact with the machine, with both hands and one foot or both feet and one hand.
- Both feet must be securely placed on the platform floor at all times. It is forbidden to sit, stand or climb on the platform guardrails.
- Never use ladders, boxes, steps, boards, or similar items on the platform to extend your reach.
- Do not allow oil, sludge or other slippery substances to remain on work shoes and platform floor.
- Keep the platform floor unobstructed.

### Tipping Hazard

 **WARNING**





- Before driving the machine onto any ground, bridge, truck or other surface, check if the loading capacity of the surface is sufficient to support the machine (machine weight + platform load). Do not drive the machine on any surfaces or edges that are not capable of fully supporting the machine.
- Operators must familiarize themselves with the ground conditions of the work area before commencing work.
- Do not operate the machine on moving surfaces or vehicles.
- The total weight of personnel, devices and materials on the platform may not exceed the platform's rated load capacity, and all loads must be kept within the designated range of the platform.
- Only low gears may be used for driving the machine on a slope.
- The machine must not be driven on slopes, steps or arched surfaces that exceed the maximum gradeability of the machine.

 **WARNING**

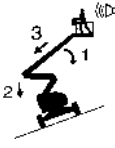
- Do not use the tilt alarm as a level indicator. The tilt alarm on the platform will only sound when the machine is severely tilted.
- If the tilt alarm sounds when the machine travels uphill on a slope, lower the boom as per the following instructions and move the machine to firm and level ground. Make sure not to rotate the boom while lowering it.
 

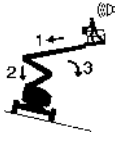

  1. Lower the main boom;
  2. Lower the articulating boom;
  3. Retract the telescoping section.
- If the tilt alarm sounds when the machine travels downhill on a slope, lower the boom as per the following instructions and move the machine to firm and level ground. Make sure not to rotate the boom while lowering it.
 



  1. Retract the telescoping section;
  2. Lower the articulating boom;
  3. Lower the main boom.
- Do not drive the machine on uneven or soft surfaces or slopes that exceed the maximum gradeability of the machine or under other hazardous conditions with the platform raised.
 



- The boom must only be raised or extended when the machine is on solid, level ground.
 

- When the machine is traveling on uneven ground, or on other rough surfaces such as gravel, or near holes, steep slopes, etc., maintain a distance of at least 0.6 m (2 ft) from potential hazards, and reduce the speed.
 

- Do not push or pull any objects located outside the platform.
 

- Never push or pull other equipment or objects using the platform or the boom.
 



- Do not place or attach any suspended load on or to any part of the machine.
 



**⚠ WARNING**

- Do not place any load outside the perimeter of the platform.
- Using the machine as a hoist or crane is strictly prohibited.
- Never attach the machine or any part of it to any adjacent object.
- When one or more tires are off the ground, first evacuate all personnel and then stabilize the machine with cranes, hoists, forklifts, or other suitable equipment.
- Without written authorization of the manufacturer, it is forbidden to modify, remove or install any parts (including counterweights), that may affect the safety and stability of the machine.
- Do not replace critical parts that affect the stability of the machine with parts of different weight or specifications. For example, batteries not only provide power, but also serve as a counterweight, and are crucial for maintaining the stability of the machine.

**⚠ WARNING**



- Do not operate the machine in wind speeds (including gusts) exceeding 12.5 m/s (28 mph). Please refer to the Beaufort wind force scale in the table below. Factors that affect wind speed include: the height of the platform, surrounding terrain, and local weather conditions, such as wind speed at height, which may be much higher than at ground level.
- Wind speeds may change at any time. Always consider the impending weather conditions, the time needed to lower the platform, and methods to monitor the current and potential wind conditions.
- When operating the machine outdoors, do not carry items with a large surface area on the platform, do not cover the surface of the platform or load, and never use additional items to increase the surface area of the platform or load. Adding such additional items will increase the exposure of the machine to the wind. Increasing the windward area will lead to reduced machine stability.

**Table 2-2**



BEAUFORT SCALE	WIND SPEED		DESCRIPTION	SURFACE CONDITIONS
	METERS/SECOND	MILES/HOUR		
0	0 - 0.2	0 - 0.5	Calm	Calm. Smoke rises vertically.
1	0.3 - 1.5	1 - 3	Light air	Direction of wind shown by smoke drift.
2	1.6 - 3.3	4 - 7	Light breeze	Wind felt on exposed skin. Leaves rustle.
3	3.4 - 5.4	8 - 12	Gentle breeze	Leaves and small twigs in constant motion.
4	5.5 - 7.9	13 - 18	Moderate breeze	Raises dust and loose paper. Small branches move.
5	8.0 - 10.7	19 - 24	Fresh breeze	Small trees sway.
6	10.8 - 13.8	25 - 31	Strong breeze	Large branches in motion. Whistling heard in telegraph wires. Umbrella used with difficulty.
7	13.9 - 17.1	32 - 38	Near gale	Whole trees in motion. Inconvenience felt when walking against the wind.
8	17.2 - 20.7	39 - 46	Gale	Twigs break from trees. Cars veer on the road.
9	20.8 - 24.4	47 - 54	Strong gale	Slight structural damage.

**DANGER**

If wind speed exceeds 12.5 m/s (28 mph) after the platform has been raised, the platform should be retracted immediately, all power sources should be disconnected, and the machine should be stopped.

## Collision and Crushing Hazards

 **WARNING**

-  All operators and other personnel in the work area must wear approved safety helmets.
- Keep all parts of the body within the platform guardrails during operation.
- Care should be taken at all times to avoid contact with stationary (built-up structures etc.) objects or moving objects (vehicles, cranes etc.) to prevent obstacles from hitting or interfering with control components or personnel on the platform.
- During operation, make sure to check the clearance and obstacles above, around and below the platform.
-  Be aware of the field of vision and potential blind spots when moving or operating the machine. Observers should be put in place in case the field of vision is obstructed.
-  When moving the machine, if the working platform is approximately 2 m (6.6 ft) away from an obstacle, use the boom or platform functions to approach the obstacle, do not use the machine's travel function.
- During operation, non-operators must maintain a distance of at least 1.8 m (6 ft) from the machine.
- When the machine is operating at height, warn other personnel not to work, stand or walk under the raised boom or platform. If necessary, the work area should be cordoned off on the ground level.
- Make sure there are no persons and/or obstacles below the platform before lowering the platform.
- Do not place hands, arms, or other body parts near areas where they may be crushed.
- Do not work under the platform or boom if the boom is not secured with appropriate lifting/supporting equipment.

 **WARNING**

- Ensure that operators of other equipment in the vicinity working at height and on the ground are aware that this MEWP is in operation.
- Limit travel speed based on ground conditions, congestion, ground slope, position of personnel, and other factors.
- Understand braking distances at all travel speeds. When traveling at high speed reduce the travel speed before stopping.
- Do not use the high speed setting when traveling in areas with limited or enclosed spaces or when reversing.
- Before releasing the brake, the machine must be placed on a horizontal surface or secured.

### 2.4 TOWING, HAULING AND LIFTING SAFETY

#### WARNING



- Except in case of emergency situations, machine malfunction, power loss or loading/unloading, it is strictly prohibited to tow or drag the machine.
- When towing or dragging the machine, comply with local policies and road traffic regulations.
- Before towing, hauling or lifting the machine, make sure that the boom is stowed, that the turntable is locked (or if equipped with turntable slewing pin, that the turntable slewing pin is locked), that there are no loose or unsecured parts on the machine, and that there are no tools left on the platform.
- Only the lifting points/rigging equipment lashing points on the chassis may be used to tow, haul or lift the machine. Ensure that the machine lifting points/rigging equipment lashing points and their rigging equipment are intact and that the belt or rope to be used has sufficient load strength.
- When towing, hauling or lifting the machine, no persons are allowed on the platform.
- Before loading/unloading the machine, ensure that the transport vehicle is parked on level ground, that the loading surface of the transport vehicle has sufficient capacity/strength to support the machine, and that the slope of the ramp used for driving the machine onto the vehicle does not exceed the maximum gradeability of the machine.
- When loading/unloading the machine, the transport vehicle must be secured to prevent it from moving.
- The wheels should be locked after the machine is loaded to prevent it from moving.
- The machine may only be lifted from a specific position with a

#### WARNING

forklift or crane with sufficient lifting capacity. Care should be taken to prevent the machine from colliding with surrounding objects.

For towing and dragging procedures, refer to the **Emergency Towing** section of this manual. For transport and lifting procedures, please refer to the **Transport and Lifting** section of this manual.

## 2.5 MAINTENANCE SAFETY

### Unsafe Maintenance Hazards

#### WARNING



- Before performing any adjustment or service operations, power off all control units and ensure that all moving parts are safely secured and cannot move unintentionally.
- Before performing any adjustment or service operations, ensure that the boom is stowed. Never work under a raised platform/boom. If it becomes necessary to work under the raised platform/boom, the platform and boom must be supported with appropriate safety supports.
- When lifting or moving heavy components of the machine, use equipment with sufficient capacity for assistance, and it should be operated by professionals with the qualifications. The lifting or moving operation shall be done gently, and pay attention to objects on the ground to prevent tripping or falling. Lift the components smoothly and at a constant speed to avoid vibration or shock, and do not allow the components to overturning or remain suspended for a long time. After moving, do not place heavy components at an unstable position.
- Before vertical lifting, ensure that all components of the assembly are securely fastened with screws. It is strictly forbidden to unscrew the fasteners of the components in the assembly.
- When machine parts are lifted by other equipment, ensure that there are no persons under and/or around the equipment.
- When striking brass rods with a mallet, make sure to wear eye protection.
- If you need to replace parts, use only original parts specified by Sinoboom. Parts replaced during maintenance should be the same or equivalent to the original machine's components.
- Do not wash the machine with water. The machine contains

**⚠ WARNING**

electronic components such as solenoid valves and sensors, which may fail or operate erratically after water ingress. If it is necessary to wash with water, turn off the emergency stop button and power switch before proceeding. Only turn the power back on after ensuring the machine is completely dry.

- Make sure the machine is turned off before using flushing equipment (such as a high - pressure water gun) to clean the machine. Do not direct water or steam ejected from the flushing equipment at electrical components, as this may cause short - circuits or electrical shocks.
- After maintenance is completed, thoroughly clean up any spilled hydraulic oil, and avoid allowing it to be spilled on the ground.
- After maintenance is completed, immediately wash off any hydraulic oil that may have come into contact with your skin.
- Waste hydraulic fluids, fuels, coolants and refrigerants must be recycled or disposed as per local regulations.

High Temperature and High Pressure Hazards

**⚠ WARNING**



- While the machine is in operation or after running for a period of time, components may generate high surface temperatures, which can cause burns upon contact. Do not touch any hot parts!
- It is forbidden to repair or tighten hydraulic hoses or seals while the machine is operating or when the oil system is under pressure.
- Before loosening or disassembling hydraulic parts (especially the counterbalance valve on the cylinder), the hydraulic pressure of all hydraulic lines should be released and the hydraulic oil should completely cool down.
- If the machine is equipped with a radiator, do not attempt to unscrew the radiator cover or touch the radiator while the coolant is still at high temperature.
- Disassemble the hydraulic components slowly to prevent the hydraulic oil from splashing and causing injuries.
- Never check for hydraulic leakages by hand. Use a piece of cardboard or stiff paper to locate leaks, and wear gloves to protect your hands from spraying hydraulic fluid.
- Do not operate the machine in case of hydraulic or air leaks. Oil or air leakage from the hydraulic system may penetrate and burn the skin.
- Never plug hydraulic leaks by hand. If there is a leak, the pressure of the hydraulic system should be released first, maintenance/repair should be carried out after the hydraulic oil has cooled down.
- If injury occurs due to high temperature and/or high pressure, seek immediate medical attention. If treatment is not carried out immediately, serious complications may result.

## Welding and Grinding Operation Hazards



 **WARNING**



- Welding, grinding and polishing operations must follow the appropriate local safety procedures.
- Before performing welding, grinding and polishing operations, turn off the machine's power, and ensure that all wires or cables are connected correctly.
- Do not use the machine as a ground wire during welding and grinding operations.
- Always make sure that all power tools are placed completely within the perimeter of the platform. Do not hang the cords of power tools on the guardrail of the platform or in any work area outside the platform, and do not hang the power tools directly by their cords.

## Fire and Explosion Hazards





 **WARNING**





- Do not operate the machine, charge the battery or refuel the machine in places where potentially flammable or explosive gases may be present.
- Refueling and charging should be carried out in a well-ventilated place without flames, sparks, and other hazards that may cause fire or explosion.
- For engine-powered machines, do not refuel the machine while the engine is running.
- Never spray ether or other starting agents into glow-plug-equipped engines (engine-powered machines).
- The electrolyte in the battery can produce explosive gases. Avoid any actions that may produce flames or sparks near the battery. Never touch the battery terminals or cable clamps with tools that can generate sparks.
- Never reverse the positive and negative terminals of the batteries.
- Only approved non-flammable cleaning solutions should be used on the machine.
- In case the machine catches fire, do not use the "water drenching method"; use a "dry powder extinguisher" to extinguish the fire.

**Battery Hazard**

 **WARNING**

- 
  - Be sure to read and adhere to the battery manufacturer's recommendations on proper battery use and maintenance procedures.
- 
  - Individuals without adequate professional qualification should not repair and maintain the battery system, otherwise this may cause personal injury or damage to the battery system.
- 
  - Individuals without adequate professional qualification should not modify parameters, signal lights, etc. during the operation of the battery system, otherwise this may cause personal injury or damage to the battery system.
- 
  - When the BMS issues an alarm, do not use the machine. Ensure that the fault has been resolved before the machine can be used.
- 
  - Always wear goggles, protective gloves and protective clothing, and remove all rings, watches and other accessories before servicing the battery. Contact with live circuits may result in death or serious injury.
- Before replacing the battery, be sure to select an appropriate number of personnel and suitable lifting methods.
  - It is forbidden to modify or dismantle the battery system without approval to avoid serious accidents.
  - When maintaining electrical components, the battery should be disconnected.
  - Do not place tools or other metal objects across the two terminals of the battery.
  - The battery charger can only be connected to a grounded three-wire AC power outlet. Make sure the charger is working properly before charging. Do not connect the battery directly to a power outlet.
  - If the battery becomes hot, deformed, leaks, emits an unusual smell, or produces smoke during

 **WARNING**

- use, stop using the battery immediately and report to the relevant maintenance personnel promptly.
- Batteries contain sulfuric acid and can produce explosive mixtures of hydrogen and oxygen. Keep any materials (including cigarette/smoking materials) that can cause sparks or flames away from batteries to prevent explosion.
- It is strictly prohibited to expose the battery to extremely high temperatures or to throw it into a fire.
- Never touch the battery terminals or cable clamps with tools that can generate sparks.
- Never charge the battery in direct sunlight. The battery should be charged in a well-ventilated place.

 **CAUTION**

- 
  - Avoid spilling battery acid or allowing it to come into contact with unprotected skin. If battery acid spills, use water mixed with bicarbonate (baking soda) to neutralize the acid. In case of contact with battery acid, rinse the acid off immediately with plenty of water and seek medical attention promptly.
  - Always keep the battery upright. If the battery is placed on its side or at an angle, liquid may spill from the battery.
  - Discarded batteries can be hazardous, and must not be treated like regular waste. If you need to discard them, please contact a battery recycling company.

## NOTICE



- Please use the charger provided by the manufacturer to charge the battery.
- The charging process must be completed in full. Frequent intermittent charging can damage the battery.
- The battery is only suitable for use with the equipment it was provided with at the time of manufacture. Do not use the battery for other purposes.
- Do not reverse the positive and negative terminals of the battery for use.
- Do not short-circuit the positive and negative terminals of the battery system.
- Do not place objects or tools on the battery to prevent short circuiting it.
- Do not strike, throw, step on, or hit the battery with sharp objects.
- Do not immerse the battery in water, acidic, alkaline or salty solutions, and protect the battery from rain.
- The battery should be fully charged immediately after each use of the machine. During charging, keep the power-off switch closed.

## NOTICE

*Battery over-discharge (continued use of battery with levels of less than 10 %) or battery under-voltage caused by long-term non-charging (battery with levels of less than 10 % not charged for more than three days), resulting in battery capacity attenuation and failure, are not covered by the warranty.*

# 3 RESPONSIBILITIES OF RELEVANT PARTIES

## 3.1 OWNER'S (OR LESSOR'S) RESPONSIBILITIES

- The owner (or lessor) is obliged to help the user understand all the instructions in the manual.
- The owner (or lessor) should provide the latest manuals or replace missing or damaged decals. To obtain the most current machine manuals please contact Sinoboom or its authorized agents.
- The owner (or lessor) should comply with local regulatory requirements related to the use of the machine.

## 3.2 EMPLOYER'S RESPONSIBILITIES

- The employer must ensure that the operator is properly trained and qualified to operate the machine.
- The employer should ensure that the user is healthy and has good judgment, sense of cooperation and psychological qualities.
- The employer has the responsibility to ensure that signalmen have good visual and auditory judgment, master standard command signals and send clear and accurate signals, and have sufficient experience to identify hazards and inform operators to avoid hazards in time.
- The employer should clarify the corresponding safety responsibilities to each operator and require them to report unsafe factors to the supervisor timely.

## 3.3 TRAINER'S RESPONSIBILITIES

- The trainer must be accredited by Sinoboom, have comprehensive knowledge training on the machine, and must have the required skills related to machine repair and maintenance.
- The trainer must conduct training in an open area free of hazards until the trainees acquire the ability to safely control and operate the machine.

## 3.4 USER'S RESPONSIBILITIES

- The user must be properly trained on MEWP, and authorized.
- The user must carefully read and fully understand this manual and the decals on the machine.
- The user must report to the owner (lessor) all anomalies that may cause the machine to work abnormally or have potential dangers, and if possible, correct the abnormal situation promptly while ensuring safety.
- The user must be fully aware of the content and procedures of the respective operation.
- The user must be familiar with and comply with signal instructions and operation requirements in emergency situations.
- The user must be vigilant in observing for any hazardous conditions and promptly report any dangers to other operators and signal personnel. This includes situations such as high-voltage lines, unrelated personnel, and unfavorable ground conditions.
- The user must stop using the equipment if it is not functioning properly or if a hazardous condition arises.

**This Page Intentionally Left Blank**

# 4 TECHNICAL PARAMETERS

## 4.1 MACHINE SPECIFICATIONS

Item	Metric	Imperial
Product Category		
Power type	Diesel engine-powered	
Axle type	Oscillating axle	
Dimensions		
Maximum platform height	21.6 m	70 ft 10 in
Maximum working height	23.6 m	77 ft 5 in
Maximum horizontal reach (230 kg/ 340 kg/454 kg)	13.35 m/11.85 m/10.4 m	43 ft 10 in /38 ft 11 in /34 ft 2 in
Maximum horizontal working envelope (230 kg/340 kg/454 kg)	13.95 m/12.45 m/11 m	45 ft 9 in/40 ft 10 in/36 ft 1 in
Maximum up and over height	8.9 m	29 ft 2 in
Overall length (stowed)	9.95 m	32 ft 8 in
Overall length (transport)	7.73 m	25 ft 4 in
Overall width (stowed)	2.49 m	8 ft 2 in
Overall width (transport)	2.49 m	8 ft 2 in
Overall height (stowed)	2.68 m	8 ft 10 in
Overall height (transport)	2.95 m	9 ft 8 in
Wheelbase	2.49 m	8 ft 2 in
Ground clearance	0.42 m	1 ft 4 in
Platform dimensions (L×W×H)	2.44 m×0.91 m×1.1 m	8 ft×3 ft×3 ft 7 in
Performance		
Rated platform capacity	230 kg (unrestricted)/340 kg (re- stricted)/454 kg (restricted)	507 lb (unrestricted)/750 lb (re- stricted)/1000 lb (restricted)
Maximum number of occupants	2 persons (unrestricted)/3 persons (restricted)	
Travel speed (stowed)	0 – 4.8 km/h	0 – 3 mph
Travel speed (elevated)	0 – 1.1 km/h	0 – 0.68 mph
Gradeability (4WD)	40%	
Turntable slewing (angle/continuity)	360°/continuous	
Platform rotation angle	180°	
Maximum allowable inclination	5°	
Turning radius (inside/outside) – 2WS	2.4 m/5.55 m	7 ft 10 in/18 ft 3 in

Item	Metric	Imperial
Turning radius (inside/outside) – 4WS	1.63 m/3.59 m	5 ft 4 in/11 ft 9 in
Turntable tailswing	0.89 m	2 ft 11 in
Tire (spec/type)	355/55D625 (foam-filled) 36×14-20 (solid)	
Maximum operating noise level	104 dB	
IP Rating	IP 54	
Maximum total vibration on the platform	2.5 m/s <sup>2</sup>	
Maximum whole body vibration value (WBV)	0.5 m/s <sup>2</sup>	
<b>Power</b>		
Drive × steer	4WD×2WS (4WS)	
Engine (power/rpm/spec/brand/emission standard)	36.4 kW/2200 rpm/D2.9 L4/Deutz/EU Stage V 36.4 kW/2200 rpm/D2.9 L4/Deutz/EPA Tier 4F 36 kW/2200 rpm/F2.8CS449/Cummins/China IV 43 kW/2200 rpm/QSF2.8T3NA60/Cummins/China III, EU Stage 3A 36.8 kW/2200 rpm/YCF3050/Yuchai/China IV 36.5 kW/2200 rpm/YCF3050 /Yuchai/China III	
Hydraulic tank capacity	130 L	28.6 gal (UK)/34.3 gal (US)
Hydraulic oil refueling volume	110 L	24.2 gal (UK)/29.1 gal (US)
Diesel tank capacity	100 L	22.0 gal (UK)/26.4 gal (US)
Hydraulic system pressure	28 MPa	4061 psi
Battery (voltage, capacity)	12 V, 220 Ah	
Control voltage	12 VDC	
<b>Weight</b>		
Gross weight (2WS)	11880 kg	26190 lb
Gross weight (4WS)	12000 kg	26455 lb
<b>Ground Bearing Data</b>		
Maximum tire load	6100 kg	13448 lb
Ground pressure	611 kPa	89 Psi
<b>Environment</b>		
Maximum allowable lateral force (restricted/unrestricted)	400 N	90 lbf
Maximum allowable wind speed	12.5 m/s	28 mph
Maximum allowable altitude	1000 m	3280 ft
Allowable ambient temperature range	-20°C – 40°C	-4°F – 104°F
Maximum allowable relative humidity	90 %	

Item	Metric	Imperial
Storage environment	Store at -20°C to 50°C (-4°F to 122°F) in a well-ventilated environment with 90% relative humidity (max.) (20°C [68°F]), protected from rain, sun, corrosive gas, flammable or explosive materials.	

**Note:**

- a) The platform height plus the operator height (assumed to be 2 m [6 ft 7 in]) equals the working height.
- b) The maximum horizontal reach plus the arm length of the operator (assumed to be 0.6 m [1 ft 11 in]) is the maximum horizontal working envelope.
- c) The ground bearing data is approximate, without considering different options, thus it is applicable only when taking an adequate safety factor into account.
- d) Different regions should use hydraulic oil, engine oil, coolant, fuel, lubricating oil, etc., that are suitable for the environmental temperature requirements.
- e) In cold weather, auxiliary devices are needed to start the machine.
- f) Rated platform load capacity refers to the maximum allowable load on the platform, including the weight of persons, materials, tools, accessories and other objects. The mass of one person shall be taken as 80 kg (176 lb).

## 4.2 FUNCTION SPEED

**Table 4-1**

Item	Parameters
Raise main boom	65 – 75 s
Lower main boom	60 – 70 s
Raise articulating boom	42 – 50 s
Lower articulating boom	46 – 54 s
Rotate the turntable (360°)	85 – 105 s
Extend the main boom	52 – 62 s
Retract the main boom	38 – 46 s
Rotate platform (180°)	18 – 22 s
Level platform upward	50 – 60 s
Level platform downward	40 – 50 s
Raise jib	32 – 38 s
Lower jib	22 – 28 s
Travel – stowed	20 – 25 s
Travel – operating	89 - 109 s
Braking distance	S ≤ 2 m (6.6 ft)

- a) The function speed depends on the start and end point of the movement rather than the controls/ switches.
- b) The drive speed test results will vary with tires of different specifications.
- c) All speed tests should be conducted from the platform controller. Test results will differ if tested from the ground controller.
- d) All tests should be conducted with the hydraulic oil temperature higher than 50 - 60 °C (122 - 140 °F). If the hydraulic oil temperature is too low, the test results will be affected.

**Test requirements:**

**Raise/lower main boom :** For this test, the articulating boom must be fully lowered, the telescopic section of the boom must be fully retracted. Raise the main boom from the lowest to the highest position, and lower it again from the highest to the lowest position. Perform these maneuvers for two times.

**Raise/lower articulating boom :** Raise the articulating boom from the lowest to the highest position, and lower it again from the highest to the lowest position. Perform these maneuvers for two times.

**Rotate turntable :** With the boom stowed, rotate the turntable through two full cycles.

**Extend/retract main boom :** With the main boom horizontally positioned, extend the main boom from the fully retracted to the fully extended position, and retract it from the fully extended to the fully retracted position again. Perform this maneuver for two times.

**Rotate platform :** With the platform horizontal, rotate the platform from the full left to the full right position, and rotate it again from the full right to the full left position. Perform this maneuver for two times.

**Level the platform :** Level the platform upward from the lowest to the highest position, and level the platform downward from the highest to the lowest position. Perform this maneuver for two times.

**Raise/lower the jib :** With the platform horizontal, raise the jib from the lowest to the highest position, and lower the jib again from the highest to the lowest position. Perform this maneuver for two times.

**Travel – stowed :** The test shall be done on a level surface. With the machine in stowed position, switch to the high speed gear, and push the drive control handle to maximum travel distance to drive forward and reverse for 30 m/98.4 ft, respectively, for two times.

**Travel – operating** : The test shall be done on a level surface. With the machine in operating position, push the drive control handle to maximum travel distance to drive forward and reverse for 30 m/98.4 ft, respectively, for two times.

**Braking distance** : As described in the “travel – stowed” test requirements, once the machine reaches the maximum drive speed, immediately release the joystick (starting timing) until the machine stops. Perform this maneuver for two times.

# 5 PRE-OPERATION INSPECTION

A pre-operation inspection must be performed before each operation, before resuming operations, and before changing operators, as well as after each repair. Please carefully check each item according to the content of this section.

## 5.1 BASIC MACHINE COMPONENTS

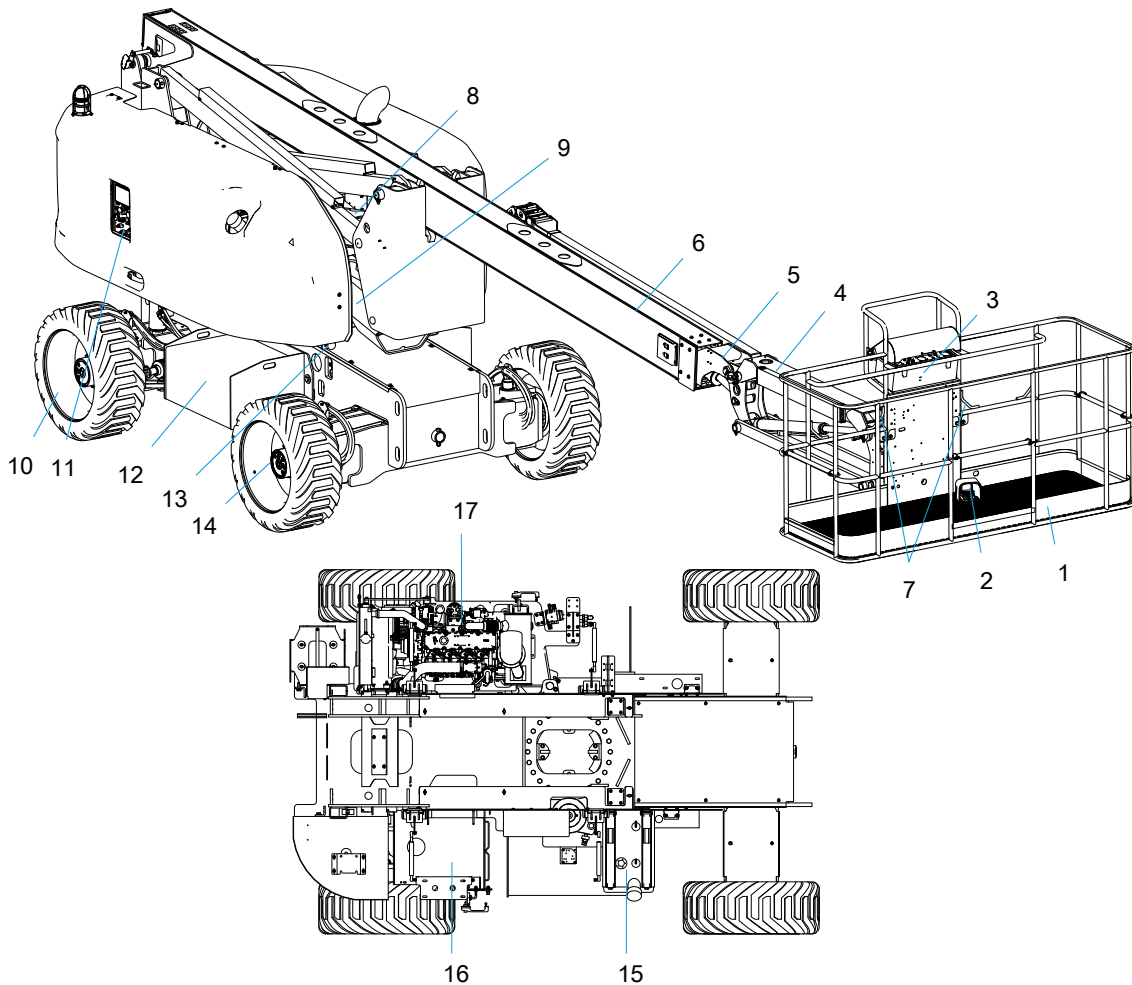

Fig. 1

Table 5-1

1. Platform	7. Harness anchorage point	13. Power-off switch
2. Foot switch	8. Upper articulating boom	14. Rear wheel
3. Platform controller	9. Lower articulating boom	15. Fuel tank
4. Jib	10. Front wheel	16. Hydraulic tank

Table 5-1 (continued)

5. Telescopic boom section	11. Turntable controller	17. Engine
6. Main boom	12. Chassis counterweight compartment	

## 5.2 MACHINE POSITIONS

The machine positions/states covered in this manual are stowed position, transport position, operating position, and non-operating position. Each position is described in detail below:

- **Stowed position:** The articulating boom is fully lowered, and the main boom is fully retracted and lowered.
- **Transport position:** The articulating boom is fully lowered, and the main boom is fully retracted and lowered. The jib and the platform are positioned as appropriate for transportation by trailer or other means.
- **Operating position:** The main boom is raised more than 5° above the fully lowered position, or the articulated boom is raised more than 5° above the fully lowered position, or the travel switch detects that the main boom is not retracted in place.
- **Non-operating position:** The main boom is raised no more than 5° above the fully lowered position, or the articulated boom is raised no more than 5° above the fully lowered position, or the travel switch detects that the main boom is retracted in place.

## 5.3 PRE-START INSPECTION

**WARNING**

**If any damage, malfunction, or unauthorized modifications differing from the factory state are found with the machine, it should be immediately tagged and shut down. Report the fault to the relevant maintenance personnel and do not operate the machine until safe operation can be guaranteed.**

The pre-start test must include the following:

1. Cleanliness – inspect all surfaces of the machine for leaks (hydraulic oil, fuel, engine oil or battery electrolyte, etc.) or foreign objects.
2. Structure – check whether there are any abnormalities in the equipment structure, such as dents, damage, cracks in welds or structural components, severe rust, severe corrosion, etc.

3. Operation Manual and Maintenance Manual – ensure that the Operation Manual and Maintenance Manual are intact, easy to read, and stored in the manuals storage box on the platform.
4. Decals and nameplate – ensure that labels and the nameplate are in place, intact, accurately located and visible.

**WARNING**

**Do not operate the machine if any label or nameplate is missing or worn.**

5. Maintenance – ensure that maintenance has been completed on the machine in accordance with the maintenance inspection requirements specified in the Maintenance Manual.
6. Battery – charge the battery as required. The electrolyte level, if adjustable, must be kept at an appropriate height.
7. Fuel level (if equipped with an engine) – add fuel as needed.
8. Engine oil level (if equipped with an engine) – make sure the oil level is between the “FULL” and “ADD” level of the oil dipstick and that the filler cap is tightened.
9. Coolant level (if equipped with a water-cooled engine) – add coolant as needed.
10. Hydraulic oil – check the hydraulic oil level. Add a suitable amount of hydraulic oil as needed.
11. Options/accessories – if the machine is equipped with any options/accessories, consult the supplemental manuals for options/accessories for inspection, operation and maintenance instructions.
12. Machine components – in addition to checking other stated items, check the following components to ensure that they are correctly installed and firmly attached without loose, missing or altered parts and visible damage, leakage or excessive wear, etc., and that all components are in their original positions and normal operating position.
  - 1) Platform assembly and gate – ensure that the foot switch is working properly and has not been altered, closed or blocked; ensure that the rope anchorage points are safe and reliable with only one person per anchorage point; make sure the latches and hinges are in normal working states, that the platform gate opens and closes

properly, is not bent or damaged, and that the surrounding area is free of obstacles. The gate should remain closed at all times, except for entering/exiting the platform and loading/unloading materials;

- 2) Turntable and platform control box – ensure that all control switches are off, joysticks are in neutral position and can return to neutral position normally once activated and released (self-resetting switches can return to neutral position normally after release), and that all control markings are visible;
- 3) Platform slewing unit;
- 4) Boom assembly;
- 5) Jib assembly;
- 6) Cable track system;
- 7) Turntable and turntable cover;
- 8) Engine, fuel tank and related components (if equipped with an engine);
- 9) Power unit and related components (if so equipped);
- 10) Turntable slewing unit;
- 11) Slewing drive components (motor, reducer, etc.);
- 12) Turntable bearings – ensure proper lubrication and no loose or missing bolts between bearings and the machine.
- 13) Turntable slewing pin (if equipped) – ensure it works properly, and ensure that the turntable slewing pin can lock/unlock the turntable;
- 14) Tire and wheel assembly – ensure that the tire and wheel assembly is firmly secured and wheel nuts are not loose or missing; check for worn tread, cuts, breakage or other abnormalities;
- 15) Drive system components (motor, reducer, etc.);
- 16) Steering linkage and steering connection plate;
- 17) Hydraulic cylinder, valve manifold, pump, oil tank, hoses, hose fittings and other hydraulic parts;
- 18) Electrical parts such as limit switches and wire harnesses.

### NOTICE

*Make sure to check the platform floor area, as inspection of this area may uncover conditions that could cause personal injury or machine damage.*

## 5.4 FUNCTIONAL TEST

Before performing a functional test:

- Choose a firm, flat and level test area.
- Make sure the test area is free from obstructions.

### WARNING

**For telescopic booms with three or more stages, when checking the telescoping function of the boom, ensure that all boom sections extend/retract together at the same speed. If any anomaly is observed, it could indicate potential movement delays and loosening of the wire ropes. In such a case immediately lower the platform to the stowed position, turn off the machine, and have the wire rope inspected and repaired by a qualified service technician.**

### WARNING

**If any switch/handle returns to neutral position and the corresponding movement does not stop, remove the foot from the foot switch or push in the emergency stop button to stop the machine.**

### NOTICE

- *When the auxiliary power is in use, do not perform two or more functions at the same time, because certain operations may not respond due to the low voltage in the auxiliary motor or pump.*
- *The auxiliary power switch can only be used for a short time (to fully lower and retract the platform from maximum angle/maximum extension) when the main power source is not working, prolonged operation may damage the electric motor.*

Follow these steps to perform a functional test:

1. With no load applied on the platform, turn the ground/platform control selector switch on the turntable controller to the ground control position, pull out the emergency stop button on the turntable controller, and perform the following tests from the turntable controller:
  - 1) Make sure that the relevant indicator lights on the display illuminate and that no error or alarm message is displayed during the entire functional test.
  - 2) Make sure that when the emergency stop button is pressed, the controller is powered off, the machine cannot be started and no functions operate.

- 3) Make sure that the horn sounds properly when the horn button is pressed.
  - 4) Activate the engine start switch – the engine should start smoothly without abnormal noise (if the machine is equipped with an engine).
  - 5) Activate any action switch without activating the enable switch, the corresponding function must not operate.
  - 6) Activate the enable switch and any action switch at the same time – the corresponding action shall operate normally.
  - 7) If equipped with an emergency power switch, with the main power source turned off, activate the emergency power switch and any boom action switch at the same time – the corresponding function shall operate normally. After that, turn off the emergency power switch.
2. Switch the ground/platform control selector switch on the turntable controller to the platform control position, pull out the emergency stop button on the turntable controller and platform controller, and perform the following tests from the platform controller:
- 1) Make sure that when the emergency stop button on the platform controller is pressed, the platform controller is powered off and no function on the platform controller can be activated.
  - 2) Make sure that the horn sounds properly when the horn button is pressed.
  - 3) Activate the engine start switch – the engine should start smoothly without abnormal noise (if the machine is equipped with an engine).
  - 4) Activate any action switch/handle without depressing the foot switch – the corresponding action will not operate.
  - 5) Depress the foot switch and activate any action switch/handle at the same time – the corresponding action shall operate normally. Move the switch/handle to the neutral position after an action is performed – the corresponding action should stop reliably and safely.
- Note:** When the travel joystick is released, the brake must be able to hold the machine on any slope within the maximum gradeability reliably without sliding.
- 6) Move any action switch/handle 7 secs after the foot switch is depressed – the corresponding action must not operate and the buzzer will sound.
  - 7) When the boom rotates beyond the rear wheels, the reverse position indicator light should flash and the travel function should be turned off. After pressing the reverse position travel drive switch,

the reverse position indicator light should illuminate steadily, and the travel function should be reactivated.

**WARNING**

**In this case, the direction of travel and steering of the machine will be opposite to the indicated direction. Operate the machine with caution!**

- 8) Test the travel speed:
  - With the machine in non-operating position, while the high/low travel speed selector switch is in lower position, move the drive function joystick – the machine will start to run at low speed. Pushing the joystick to the full drive position will bring the machine to travel at the maximum speed in low speed mode.
  - With the machine traveling in non-operating position, push the high/low travel speed selector switch upward to upper position – the machine will also start to travel at high speed. Pushing the joystick to the full drive position will bring the machine to travel at the maximum speed.
  - With the machine in operating position, while the high/low travel speed selector switch is in lower position, move the drive function joystick – the machine will start to run at low speed. Push the high/low travel speed selector switch upward to upper position – the machine will remain at low speed.
- 9) When the machine travels on a slope with a grade greater than or equal to the maximum allowable tilt angle of the machine, the chassis tilt indicator icon will illuminate, and the tilt alarm will be triggered.
- 10) If equipped with an emergency power switch, with the main power source turned off:
  - i. depress the foot switch, and activate the emergency power switch and drive function joystick at the same time – the machine can't travel.
  - ii. depress the foot switch, and activate the emergency power switch and any boom action switch at the same time – the corresponding action should operate normally.
  - iii. After that, turn off the emergency power switch.

# 6 CONTROLLERS AND INDICATORS

This chapter provides a brief introduction of switches, handles and displays on the turntable controller and platform controller. Refer to the **Operation Instructions** section for a detailed description.

## 6.1 TURNTABLE CONTROLLER

### NOTICE

The manufacturer cannot directly control the application and operation of the machine. Users and operators are responsible for complying with the applicable safety specifications.

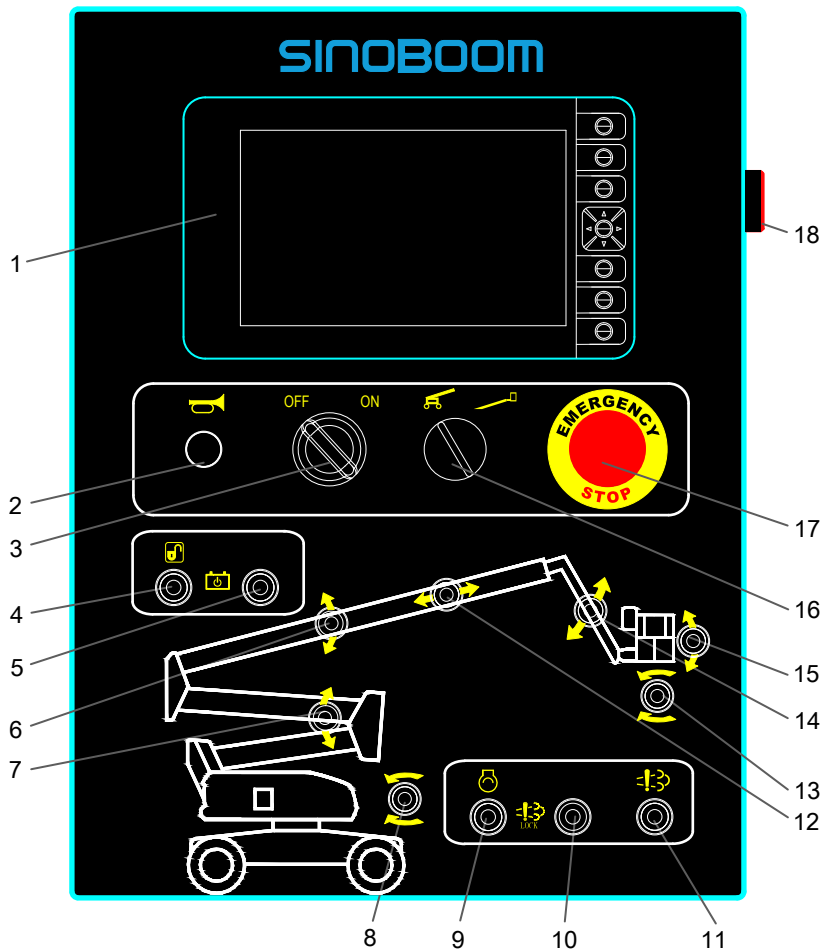
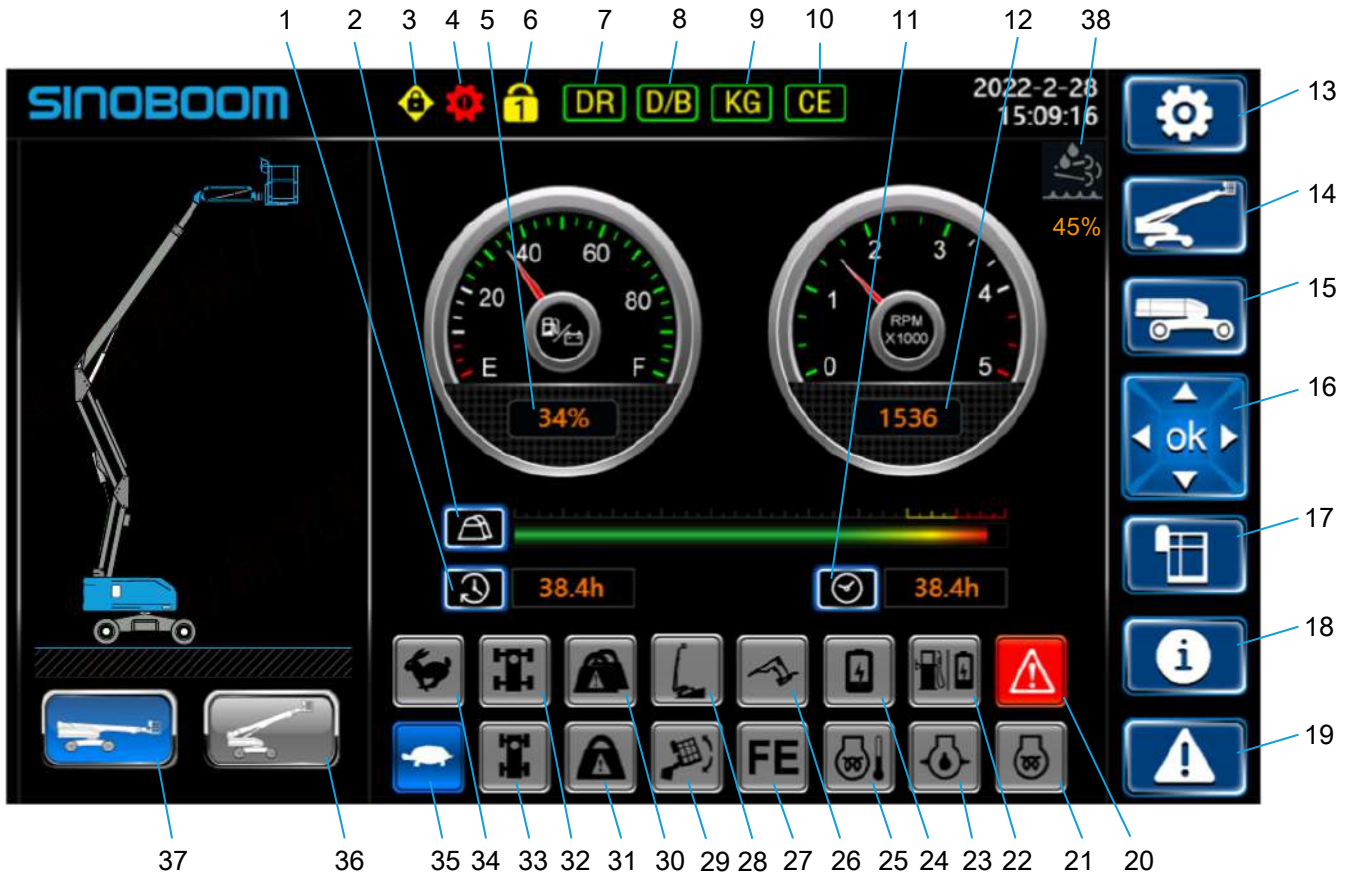

Fig. 1

**Table 6-1**

No.	Name	Description
1	Turntable display	Provides machine working states, engine states, fuel/battery level, alarm information, fault codes & query, and other information.
2	Horn	Press the button for the horn to sound.
3	Key switch	Turn the switch to ON position, the machine will be powered on; Turn the switch to OFF position, the machine will be powered off.
4	Enable switch	Move and hold the switch – all functions will be enabled to operate.
5	Auxiliary power switch	Move the switch – the emergency power pump will be started.
6	Main boom lift switch	Provide main boom lifting and lowering control function
7	Articulating boom lift switch	Controls articulating boom lifting and lowering
8	Turntable slew switch	Controls turntable slewing
9	Engine start switch	Move the switch – the engine will be started.
10	After-treatment regeneration disable switch (if equipped)	Move the switch, and the engine cannot enter the regeneration state.
11	After-treatment regeneration request switch (if equipped)	With the after-treatment regeneration disable switch turned off, move this switch, and the engine after-treatment device will enter regeneration state.
12	Main boom telescope switch	Provide main boom telescoping control function
13	Platform rotate switch	Provide platform rotation control function
14	Jib lift switch	Provide jib lifting/lowering control function
15	Platform level switch	Adjusts platform levelness while traveling uphill/downhill on a slope
16	Ground/platform control selector switch	Turn the switch to the left to Ground control position, and all functions will be operative only at the turntable controller, while the platform controller will not work; turn the switch to the right to Platform control position, and all functions will be operative only at the platform controller, while the turntable controller will not work.
17	Emergency stop button	When pulled to the “ON” position the machine can be started normally; pushing the button to the “OFF” position will deactivate the controller, the machine cannot be started and no functions can be activated.
18	Buzzer	The buzzer emits sound and light alarms with different frequencies in different situations

**6.2 TURNTABLE DISPLAY**



**Fig. 2 Turntable controller display**

**Table 6-2**

No.	Name	Description
1	Current operating hours	Indicates the machine’s current operating hours.
2	Platform load	Indicates the load weight on the platform.
3	Dynamic password disactivated indication	This icon will disappear once the dynamic password is activated.
4	Factory default unset indication	This icon will disappear once the factory default is set.
5	Fuel level indicator	Indicates the remaining fuel oil in percentage, when the remaining fuel oil below 20%, refuel immediately.
6	Lock status indication	The machine has been locked, contact an authorized agent or manufacturer for unlocking. Icons in different colors represent different levels of locking status.
7	DR	This icon appears to indicate that drive movement is restricted when the machine is in operating position.
8	D/B	This icon appears to indicate that travel and boom movements can be performed simultaneously.

**Table 6-2 (continued)**

No.	Name	Description
9	KG	This icon appears to indicate that many movements of the machine in operating position are restricted when the platform is overloaded.
10	CE	This icon appears to indicate the CE standard has been set. There are CE, ANSI, CSA, AS, KCS, JIS, EAC and UKC for selection.
11	Accumulated operating hours	Indicates the machine's accumulated operating hours.
12	Tachometer	Indicates the current engine speed.
13	Setting Menu	Press the key to the right of the icon to enter the setup interface for language and commissioning setting.
14	Machine info	Press the key to the right of the icon to enter the machine information interface for time setting, and sensor, detection switch, proportional valve and engine information query.
15	Turntable panel information	Press the key to the right of the icon to enter turntable information interface to check the input state of switches at the turntable control panel.
16	Navigation selection key	Press the key on the right side of the icon to change the selection, confirm the changes, or enter an interface, etc.
17	Platform Information	Press the key to the right of the icon to enter platform information interface to check the input and output states of switches at the platform controller panel and the handles state at the platform controller.
18	Machine Information	Press the key to the right of the icon to enter the Machine Information interface for enquiry of product serial number, running time, program version and other information, and modifying product serial number and model.
19	Alarm message	Press the key to the right of the icon to enter alarm message interface to check the system alarm or fault state.
20	Fault alarm indicator	This icon illuminates to indicate a system failure.
21	Glow plug indicator	This icon illuminates to indicate that the engine is taking in air for preheating.
22	Low fuel level indicator	This icon illuminates to indicate that the fuel oil is insufficient.
23	Engine oil pressure alarm indicator	This icon illuminates to indicate that the engine oil pressure is too low.
24	Charging indicator	This icon illuminates to indicate that the machine is charging.
25	Coolant temp alarm indicator	This icon illuminates to indicate that the engine coolant temperature is too high.
26	Hydraulic generator ON indicator	This icon illuminates to indicate that the hydraulic generator is started.
27	Not used	\
28	Chassis inclination indicator	This icon illuminates to indicate that the chassis inclination exceeds the maximum allowable tilt angle.
29	Platform tilt alarm indicator	This icon illuminates to indicate that the platform is tilted.

**Table 6-2 (continued)**

No.	Name	Description
30	Heavy load indicator	This icon illuminates to indicate that the load on the platform exceeds the lower load range.
31	Overload alarm indicator	This icon illuminates to indicate that the load on the platform exceeds its rated load.
32	Axle extend limit indicator (if equipped)	This icon illuminates to indicate that the extending axles have been fully extended.
33	Axle retract limit indicator (if equipped)	This icon illuminates to indicate that the extending axles have been fully retracted.
34	High engine speed indicator	This icon illuminates to indicate that the engine is running at high speed.
35	Low engine speed indicator	This icon illuminates to indicate that the engine is running at low speed.
36	Operating position indicator	This icon illuminates to indicate that the machine is in operating position.
37	Non-operating position indicator	This icon illuminates to indicate that the machine is in non-operating position.
38	Urea level indication (if equipped)	Indicates the current urea level in percentage: If the value is below 30%, it is recommended to add urea until the percentage exceeds 30% before operating the machine; if the value is below 15%, it is necessary to add urea until the percentage is at least above 15% before machine operation is permitted.

### 6.3 PLATFORM CONTROLLER

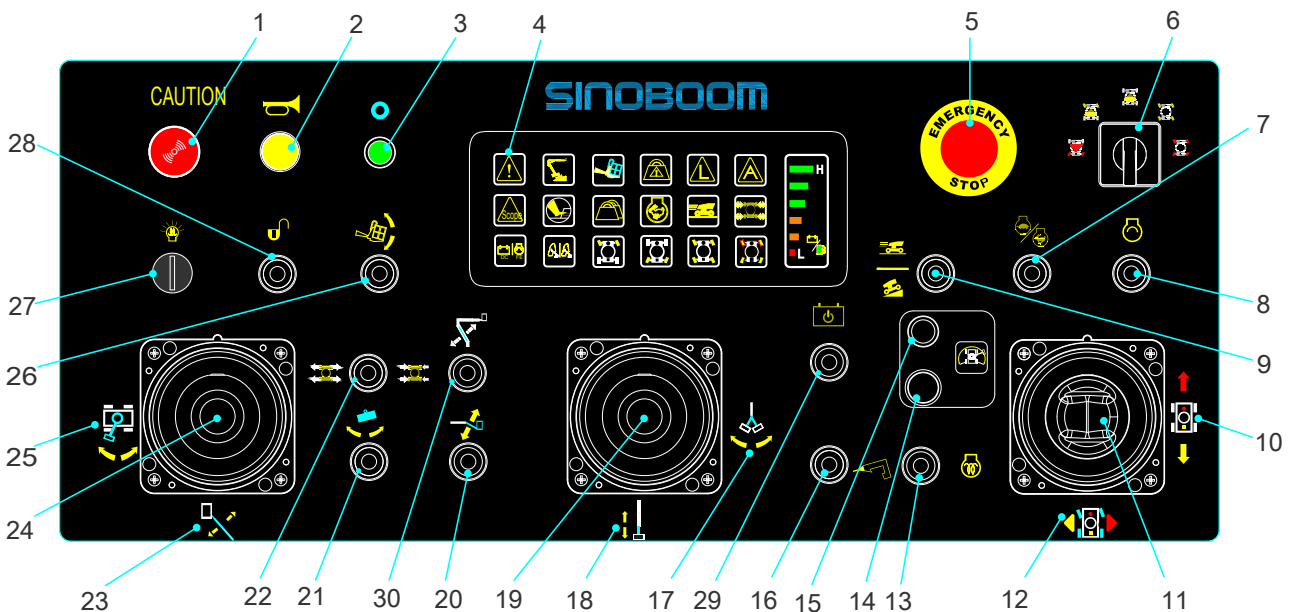

**Fig. 3 Platform Controller**

**Table 6-3**

No.	Name	Description
1	Buzzer	The buzzer emits sound and light alarms with different frequencies in different situations
2	Horn	Press the button to sound the horn.
3	Power indicator	This indicator illuminates to indicate that the power supply to the platform controller operates normally.
4	Platform display screen	Displays the current fuel level/battery level and faults
5	Emergency stop button	When pulled to the “ON” position the machine can be started normally; pushing the button to the “OFF” position will deactivate the controller, the machine cannot be started and no functions can be activated.
6	Steering mode selector switch (if equipped)	Switches among rear-wheel steering, front-wheel steering, straight driving, crab steering, and four-wheel steering modes.
7	High/low engine speed selector switch	Switches between high/low engine speed.
8	Engine start switch	Move the switch – the engine will be started.
9	High/low travel speed selector switch	Switches between high/low travel speed
10	Travel control indication	Provides indication for travel control
11	Travel/steer joystick	Push the joystick forward/backward to drive the machine forward/backward;
		Press the left/right button on the joystick to steer the machine to left/right
12	Steering control indication	Provides indication for wheel steering control
13	Glow plug switch (if equipped)	Move and hold the switch 6 – 10s, and the engine will take in air for preheating.
14	Reverse position travel switch	Press this switch when the reverse position indicator is flashing – the travel function will resume. Please note that in this case the traveling and steering direction of the machine is opposite to the indicated direction.
15	Reverse position indicator	This indicator flashes to indicate that the boom has moved beyond the rear wheel.
16	Hydraulic generator switch (if equipped)	Turn on/off the hydraulic generator.
17	Jib rotate control indication (if equipped)	Provides indication for jib rotating control.
18	Main boom telescope control indication	Provides indication for main boom telescoping control.
19	Main boom telescope/jib rotate (if equipped) control handle	Push the handle to the left/right to rotate the jib clockwise/anti-clockwise.
		Push the handle forward/backward to retract/extend the main boom.
20	Jib lift switch (if equipped)	Provide jib lifting/lowering control function
21	Platform rotate switch	Provide platform rotation control function
22	Extending axle telescope switch (if equipped)	Controls extending axle extending and retracting

**Table 6-3 (continued)**

No.	Name	Description
23	Main boom lift control indication	Provides indication for main boom lifting/lowering control
24	Main boom lift/turntable slew control handle	Push the handle to the left/right to rotate the turntable clockwise/counterclockwise;
		Push the handle forward/backward to raise/lower the main boom
25	Turntable slew control indication	Provides indication for turntable slewing control
26	Platform level switch	Adjusts platform levelness while traveling uphill/downhill on a slope
27	Work light switch (if equipped)	Turns the work light on/off
28	Release switch (if equipped)	After the operator protective function has been triggered, activate this switch to continue in override mode.
29	Auxiliary power switch	Provides auxiliary (emergency) power in case of main power source failure.
30	Articulating boom lift switch (if equipped)	Controls articulating boom lifting and lowering

## 6.4 PLATFORM DISPLAY SCREEN

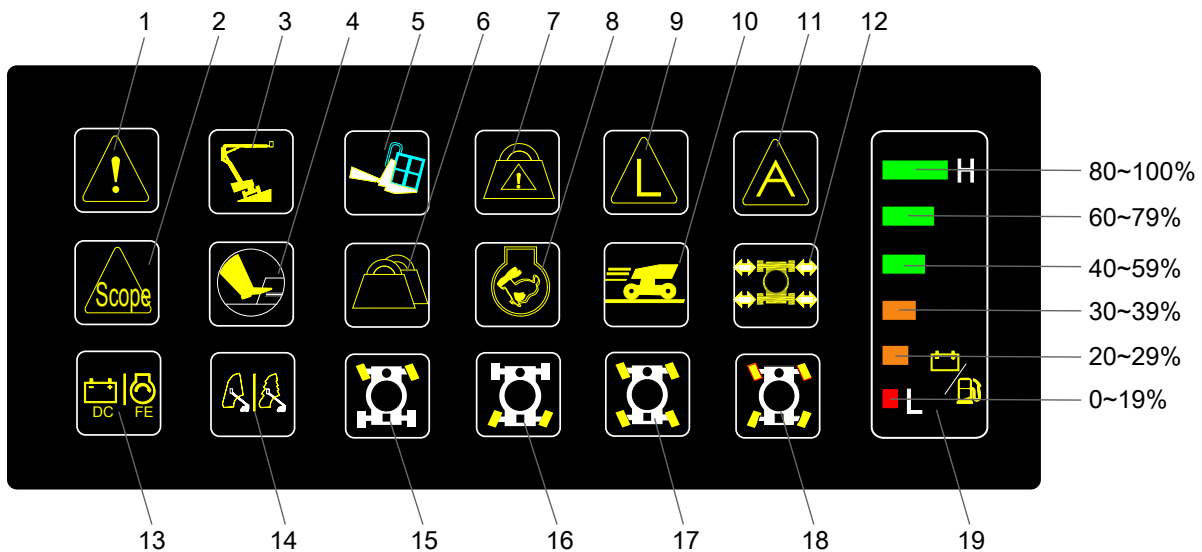

**Fig. 4 Platform Controller Display**

**Table 6-4**

No.	Name	Description
1	System fault indicator	This icon illuminates to indicate low fuel level, low engine oil pressure, high engine coolant temperature, CAN bus error, or other faults.
2	Reach limiting indicator	This icon illuminates to indicate that the boom has exceeded the specified working envelope.

**Table 6-4 (continued)**

No.	Name	Description
3	Chassis inclination indicator	This icon illuminates to indicate that the chassis inclination exceeds the maximum allowable tilt angle.
4	Foot switch indicator	This icon illuminates to indicate that the foot switch is depressed.
5	Platform tilt indicator	This icon illuminates to indicate that the platform is tilted.
6	Heavy load indicator	This icon illuminates to indicate that the load on the platform exceeds the lower load range.
7	Overload alarm indicator	This icon illuminates to indicate that the load on the platform exceeds its rated load.
8	High engine speed indicator	This icon illuminates to indicate that the engine starts to run at high speed.
9	Boom length sensor fault indicator	This icon illuminates to indicate boom length sensor faults.
10	High travel speed indicator	This icon illuminates to indicate that the machine starts to travel at high speed.
11	Angle sensor fault indicator	This icon illuminates to indicate angle sensor faults.
12	Extending axle telescope indicator	This icon flashes to indicate that the extending axles are retracting/extending.
		This icon illuminates to indicate that the extending axles have been fully extended.
13	Not used	\
14	Main boom auto-control mode indicator	This icon illuminates to indicate that the main boom enters auto-control mode.
15	Front-wheel steer indicator	This icon illuminates to indicate that the machine enters front wheel steering mode.
16	Rear wheel steer indicator	This icon illuminates to indicate that the machine enters rear wheel steering mode.
17	Crab steer indicator	This icon illuminates to indicate that the machine enters the crab steering mode.
18	Four-wheel steer indicator	This icon illuminates to indicate that the machine enters four-wheel steering mode.
19	Fuel level indicator	Indicates the current fuel level, when the fuel level below 20%, refuel immediately.

# 7 OPERATION INSTRUCTIONS

## 7.1 GENERAL

This mobile elevating work platform is used to transport people and tools to work locations and for performing tasks on the work platform. This machine has two control positions: ground control position and platform control position.

### WARNING

- **Except in case of emergency, it is forbidden to perform operations from the ground if any person is still on the platform.**
- **If any switch/handle returns to neutral position and the corresponding movement does not stop, remove the foot from the foot switch or push in the emergency stop button to stop the machine.**
- **Do not operate the machine to perform actions such as traveling, turntable slewing, boom extending, boom lowering, jib lowering, jib rotating, platform leveling down, or platform rotation after the platform has touched the ground.**

## 7.2 WORKING ENVELOPE DIAGRAM

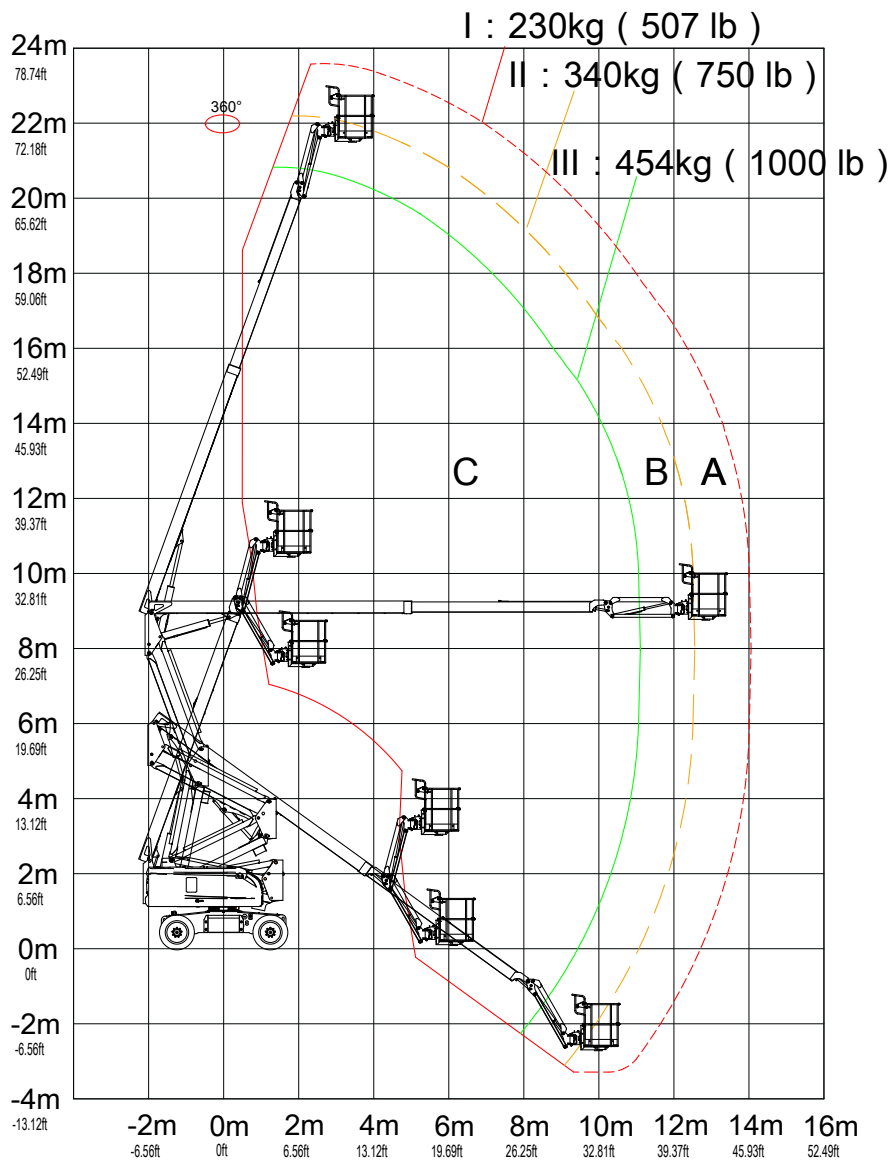

Fig. 1 Working Envelope Diagram (-5°)

## 7.3 COMMON ALARM MESSAGES

In case of an alarm, you can check the alarm message on the **ALARM INFO** interface of the turntable display. The common alarm messages are as follows:

**Table 7-1**

Fault description	Cause and solution
Engine coolant temperature alarm	The engine coolant temperature is high. Shut down the machine immediately, allowing the engine coolant to cool down to normal temperature naturally.
Hydraulic oil temperature alarm	The hydraulic oil temperature is high. Shut down the machine immediately, allowing the hydraulic oil to cool down to normal temperature naturally.
Battery level alarm	The battery level is below 20%, charge the battery immediately.
Scope Alarm	The actual working envelope of the boom has exceeded the specified working envelope. Adjust the boom to the allowable working envelope.
Overload Alarm	The loads on the platform have exceeded its rated load, remove the excess load.
Heavy Load Warning	The loads on the platform have exceeded the lower load range (i.e. 80% of the rated load).
Turntable Tilt Alarm	The chassis inclination exceeds the maximum allowable tilt angle. If the boom is raised or extended at this time, operate the machine to retract the boom into place, and then lower the boom into position. After that, readjust the machine's inclination within the allowable range.
Platform Tilt Alarm	The platform tilt angle has exceeded the allowable angle. Level the platform.
Crush Protect Alarm	<p>The operator protective function has been triggered, you can release action restrictions and remove the alarm as follows:</p> <ul style="list-style-type: none"> <li>• Depress the foot switch while operating the release switch on the platform controller – the boom may be retracted and lowered, and the turntable may rotate slowly.</li> <li>• Ensure the machine is in a safe position, lift the round bar up until the angle brackets on both sides are attracted by the magnet again. Then, the strobe light will turn off, and the machine will resume all operations.</li> </ul>

## 7.4 STABILITY

Regarding the stability of the machine it is necessary to take two key situations into consideration: stability over the front (forward stability) and stability over the rear (backtip stability) of the machine. See the following figures and description for the least stable positions, both over the front and over the rear of the machine.

 **WARNING**

**Do not overload the platform or operate the machine on tilted surfaces exceeding the maximum allowable tilt angle to prevent forward or backward tipping.**

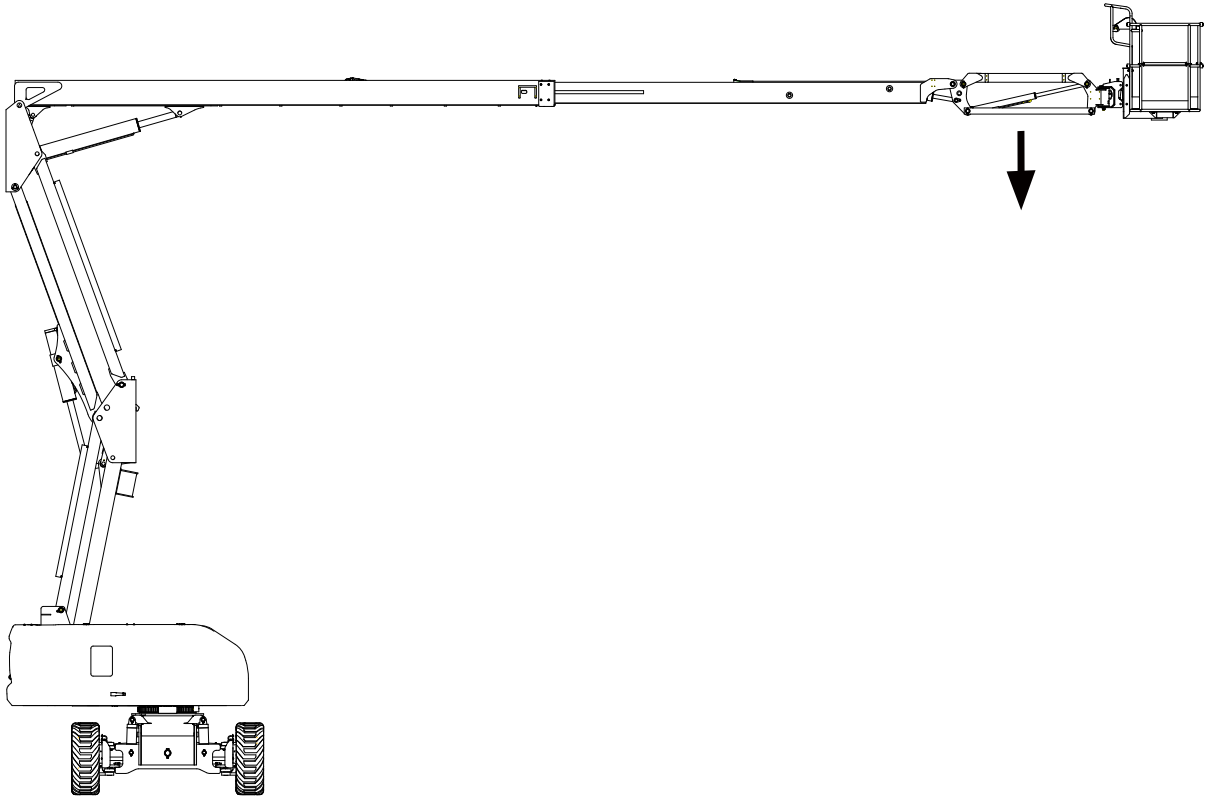

**Fig. 2 Position of lowest forward stability of the machine**

1. Articulating boom fully lifted;
2. Main boom lifted to horizontal position;
3. Telescopic boom section fully extended;
4. Jib lifted to horizontal position;
5. Turntable rotated 90°;
6. The machine will tip over in the direction as indicated by the arrow if overloaded or operating on a tilted surface exceeding the maximum allowable tilt angle.

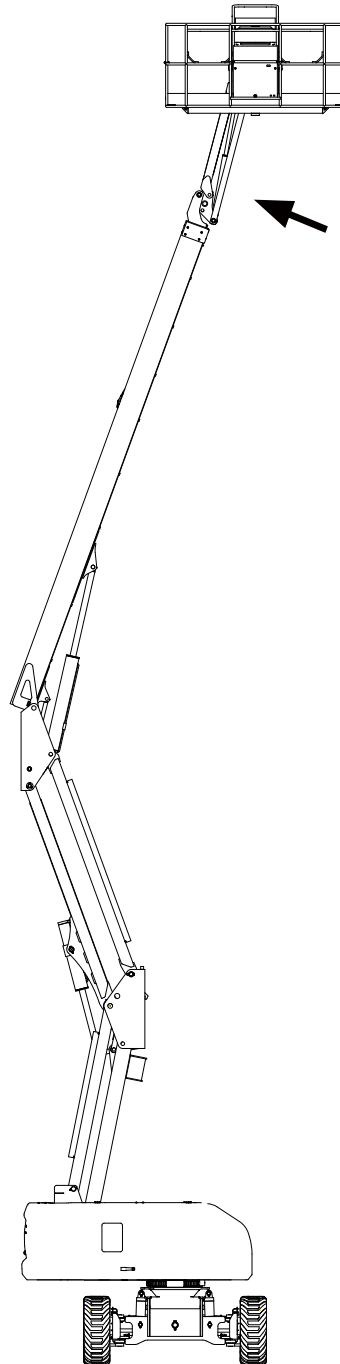

**Fig. 3 Position of lowest backtip stability of the machine**

1. Articulating boom fully lifted;
2. Main boom fully elevated;
3. Telescopic boom fully retracted;
4. Jib fully lifted;
5. Turntable rotated 90°;
6. Platform rotated 90°;
7. The machine will tip over in the direction as indicated by the arrow if overloaded or operating on a

tilted surface exceeding the maximum allowable tilt angle.

## 7.5 GRADEABILITY

Gradeability refers to the maximum allowable slope angle the machine can achieve on firm ground with sufficient traction, the platform in stowed position and occupied by only one person. Gradeability will decrease when the load on the platform increases.

### WARNING

**Do not drive the machine on slopes exceeding the machine's maximum gradeability.**

The gradeability includes uphill/downhill as well as lateral slope capability. Uphill/downhill gradeability of this machine:

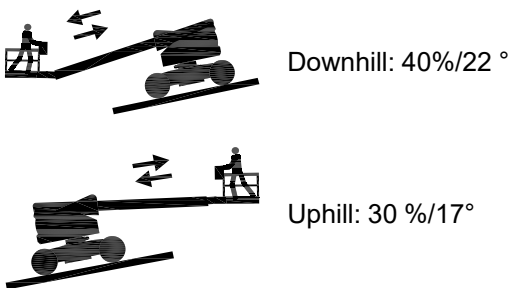

Lateral slope limit:

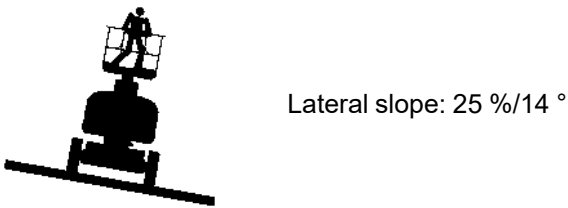

**Note:** It is recommended to climb a slope with the platform in the “downhill” position.

## 7.6 ENGINE OPERATION

### Startup Sequence

**Note:** The first start must always be done from the ground control position.

### NOTICE

*If the engine fails to get started immediately, do not keep starting the engine for too long, and try to start the engine again. If a restart still fails, allow the starter to cool down for 2 - 3min. If the engine still fails to get started after several attempts, please reference the engine manual.*

*Before applying any load, allow the engine to run at low speed for 3min - 5min to warm up.*

*Do not start the engine when the foot switch (if equipped) is depressed.*

**Note:** Before starting the engine, the operator should first turn on and hold the engine glow plug switch for 6 - 10s to let the engine take in air for preheating. Due to different ambient temperatures, the warm-up time will be different, and the engine can only be started after the engine glow plug icon goes out (an electronically controlled engine can be preheated automatically).

### Start machine from the ground

1. Turn always be done ground/platform control selector switch at the ground controller to the ground control position.
2. Turn always be done emergency stop button at the ground controller to the ON position.
3. Turn always be done key switch at the ground controller to the ON position.
4. Move always be done engine start switch (no more than 15s) at the ground control position to start the engine.

### Start machine from the platform

1. Turn the ground/platform control selector switch at the ground control position to the Platform control position.
2. Pull out the emergency stop button at the ground control position and platform control position to the ON position.
3. Turn the key switch at the ground control position to the ON position.
4. Move the engine start switch (no more than 15 s) at the platform control position to start the engine.

### Shutdown Sequence

### NOTICE

*If the machine is shut down unexpectedly due to engine failure, make sure to correct the failure before restarting the engine.*

1. Remove all loads and set the machine in stowed position.

2. Let the engine run at low speed for 3 min – 5 min to further lower the internal temperature of the engine.
3. Press the emergency stop button on the lower controller and upper controller to OFF position.
4. Turn the key switch at the ground control position to OFF position.

## 7.7 EXHAUST AFTER-TREATMENT SYSTEM-IF EQUIPPED

The exhaust after-treatment (EAT) regeneration system is used to control the exhaust gas for engine. In order to ensure the normal operation of the system, make sure to perform regeneration process for the after-treatment device as required.

### EAT Regeneration Process

Before performing EAT regeneration process, make sure to:

- Stop all functional operation of the machine
  - Set the machine in stowed position
  - Evacuate all personnel from the platform
  - Run the engine at idle speed
  - Keep the coolant temperature above 60°C
  - Select the ground control position for the machine
1. When the machine needs EAT regeneration, a yellow warning prompt will appear on the EAT System Information interface, and the status indicator will flash.
  2. Move the machine to a suitable area.
  3. Activate the regeneration function for the type of engine equipped, and then the EAT System Information interface will display a red warning prompt. The whole EAT regeneration process takes about 30 min – 60 min.
  4. After completing the EAT regeneration process, the engine will run for about 5 minutes to cool itself and the EAT system.

#### Regeneration function activation instructions:

1. If the machine is equipped with after-treatment regeneration disable switch, make sure to turn off the switch.
2. Move the after-treatment regeneration request switch, the engine will enter regeneration status.

### Cancel EAT Regeneration Process

#### NOTICE

*If the machine is shut down unexpectedly due to engine failure, make sure to correct the failure before restarting the engine.*

Cancel EAT regeneration process immediately if:

- Ground/platform control selector switch is turned from ground control position to platform control position.
- Any movement switch is turned on.
- Engine is powered off.

If EAT regeneration process is interrupted, make sure to restart EAT regeneration process afterwards.

### EAT Regeneration Failed

If EAT regeneration process is not completed within the specified time, a red warning message will be displayed on the EAT System Info interface, and the corresponding fault indicator light will light up. In such case, you need to contact the engine manufacturer to complete the EAT regeneration process.

## 7.8 TURNTABLE SLEWING

#### WARNING

**Before slewing the turntable, make sure that the boom has sufficient distance from surrounding walls, obstacles, etc.**

#### Perform operation from the ground:

1. Rotate the turntable clockwise: Move and hold the enable switch, and push the turntable slew switch downwards, the turntable will rotate clockwise.
2. Rotate the turntable counterclockwise: Move and hold the enable switch, and push the turntable slew switch upwards, the turntable will rotate counterclockwise.

#### Perform operation from the platform:

1. Rotate the turntable clockwise: Depress the foot switch, push the main boom lift/turntable slew control handle to the left, the turntable will rotate clockwise.
2. Rotate the turntable counterclockwise: Depress the foot switch, push the main boom lift/turntable slew control handle to the right, the turntable will rotate counterclockwise.

**Note:** When performing the operation from the platform, the rotation speed of the turntable is in direct proportion to the travel distance of the control handle. The shorter the travel distance, the slower the speed.

## 7.9 TRAVELING

**WARNING**

- The machine cannot travel with the boom positioned higher than the horizontal unless it is on a solid and flat surface without exceeding the maximum gradeability.**
- The machine must not be driven on slopes, steps or arched surfaces that exceed the maximum gradeability of the machine.**
- Before traveling, confirm the traveling control direction, and make sure the boom is above the rear-wheel drive axle. If the boom is above the front-wheel axle, the traveling and steering control directions will be opposite to the indicated directions.**
- Extreme care must be taken when driving the machine in reverse or with the platform raised.**
- When driving the machine in potentially dangerous situations such as driving on slopes or reversing, operate the handle in small increments to avoid danger due to excessive speed.**

**Note:** The travel speed is in direct proportion to the travel distance of the joystick. The shorter the travel distance, the slower the speed.

### Drive Forward and Reverse

1. Drive forward: Depress the foot switch and push the travel/steer joystick forward, the machine will travel forward.
2. Drive reverse: Depress the foot switch and push the travel/steer joystick backward, the machine will travel backward.
3. When the boom is above the rear-wheel drive axle, the control direction of traveling and steering of the platform controller will be indicated by the red and yellow directional arrows on the chassis.
4. When the boom moves beyond the rear wheel, the reverse position indicator will flash, and the travel function will be turned off. To restore the travel function: Press the reverse position travel switch, the reverse position indicator will illuminate, and the travel function will resume. (At this time, the control direction of traveling and steering of the machine will be opposite to the red and yellow directional arrows on the chassis)

### Steering While Traveling

**Steering mode switching:** The steering mode is controlled by the steering mode selector switch. To steer the machine, turn the steering mode selector switch to the icon of the desired steering mode, the corresponding steering mode indicator on the platform display will illuminate to indicate the current steering mode. (if equipped)

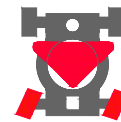

Fig. 4 Rear wheel steering mode



Fig. 5 Front wheel steering mode



Fig. 6 Crab steering mode



Fig. 7 Four-wheel steering mode

- Steer left: Depress the foot switch, push the travel/steer joystick forward and press the left button on top of the joystick, the machine will steer left.
- Steer right: Depress the foot switch, push the travel/steer joystick forward and press the right button on top of the joystick, the machine will steer right.

### Travel on Slopes

**WARNING**

**The machine must not be driven on slopes, steps or arched surfaces that exceed the maximum gradeability of the machine.**

Before traveling on a slope, please determine:

1. The machine's maximum gradeability.
2. The slope grade. To determine the slope grade:
  - Use a suitable carpenter's ruler, a straight piece of wood and a tape measure.
  - Measure the height (H) and length (L) of the slope.

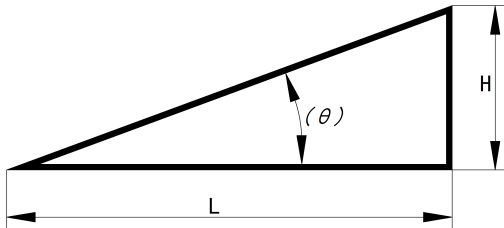

Fig. 8

- Slope grade =  $H/L \times 100\%$ .

### High and Low Travel Speed Switching

**WARNING**

- In a tilted condition the machine must be driven at low speed.
- Before switching to high speed gear, make sure to first observe whether the surrounding environment is safe; if not, it is possible that collisions with obstacles or other people and other hazards may occur while traveling at high speeds.
- Continuous high-speed travel of the machine for a long time can cause the gear oil temperature inside the drive reducer to become too high, which may damage the seal and lead to oil leakage. To prevent this situation, the continuous high-speed travel time of the machine shall not exceed 30 minutes.

**NOTICE**

*In travel mode, the engine can be switched between high and low speeds as needed (if equipped with an engine).*

The machine has two speed gears: high speed and low speed. You can switch the speed gear by moving the high/low travel speed selector switch.

1. With the machine traveling in non-operating position, push the high/low travel speed selector switch upward to upper position (high-speed gear), the travel speed will be switched to high speed and the high travel speed indicator light will be on; push the

travel control handle to full drive position, the machine will travel at the maximum travel speed.

**NOTICE**

- Before traveling in a non-operating position, if the high/low travel speed selector switch remains in the high-speed position after the drive function is activated, the machine will start to run at high speed immediately.
- With the machine traveling in non-operating position, push upward the high/low High/low travel speed selector switch – the machine will also start to travel at high speed.

2. With the machine traveling in non-operating position, push the high/low travel speed selector switch downward to lower position (low-speed gear), the travel speed will be switched to low speed and the high travel speed indicator light will be off; push the travel control handle to full drive position, the machine will travel at the maximum travel speed in low-speed mode.
3. With the machine traveling in the operating position, the machine can only travel at low speed, and the travel speed can't be changed by pushing the high/low High/low travel speed selector switch.

**Note:** The travel speed is in direct proportion to the travel distance of the joystick. The shorter the travel distance, the slower the speed.

### 7.10 BOOM MOVEMENTS

**WARNING**

**Do not position the boom above the horizontal while driving the machine on slopes exceeding the maximum allowable tilt angle.**

**Perform operation from the ground:**

1. **Raise the main boom:** Move and hold the enable switch and then push the main boom lift switch upwards – the main boom will be raised.
2. **Lower the main boom:** Move and hold the enable switch and then pull the main boom lift switch downwards – the main boom will be lowered.
3. **Extend the main boom:** Move and hold the enable switch and then push the main boom telescope switch to the right – the main boom will be extended.
4. **Retract the main boom:** Move and hold the enable switch and then push the main boom telescope switch to the left – the main boom will be retracted.

5. **Raise the articulating boom:** Move and hold the enable switch, push the articulating boom lift switch upwards, and the articulating boom will be raised.
6. **Lower the articulating boom:** Move and hold the enable switch, pull the articulating boom lift switch downwards, and the articulating boom will be lowered.
7. **Raise the jib:** Move and hold the enable switch and then push the jib lift switch upwards – the jib will be raised. (if equipped)
8. **Lower the jib:** Move and hold the enable switch and then pull the jib lift switch downwards – the jib will be lowered. (if equipped)
9. **Rotate the jib clockwise:** Move and hold the enable switch and then pull the jib rotate switch downwards - the jib will rotate clockwise. (if equipped)
10. **Rotate the jib counterclockwise:** Move and hold the enable switch, push the jib rotate switch upward - the jib will rotate counterclockwise. (if equipped)

9. **Raise the jib:** Depress the foot switch and then push the jib lift switch upward – the jib will be raised. (if equipped)
10. **Lower the jib:** Depress the foot switch and then pull the jib lift switch downwards – the jib will be lowered. (if equipped)
11. **Rotate the jib clockwise:** Depress the foot switch and then push the main boom telescope/jib rotate control handle to the left - the jib will rotate clockwise. (if equipped)
12. **Rotate the jib counterclockwise:** Depress the foot switch and then push the main boom telescope/jib rotate control handle to the right - the jib will rotate counterclockwise. (if equipped)

### Perform operation from the platform:

**Note:** When operating from the platform, the speed of main boom lifting/lowering is in direct proportion to the travel distance of the handle. The shorter the travel distance, the slower the speed.

1. **Raise the main boom:** Depress the foot switch and then push the main boom lift/turntable slew control handle forward – the main boom will be raised.
2. **Lower the main boom:** Depress the foot switch and then pull the main boom lift/turntable slew control handle backward – the main boom will be lowered.
3. **Retract the main boom:** Depress the foot switch and then push the main boom telescope/jib rotate control handle forward, and the main boom will be retracted.
4. **Extend the main boom:** Depress the foot switch and then push the main boom telescope/jib rotate control handle backward, and the main boom will be extended.
5. **Raise the articulating boom:** Depress the foot switch and push the articulating boom lift switch upwards – the articulating boom will be raised.
6. **Lower the articulating boom:** Depress the foot switch and pull the articulating boom lift switch downwards – the articulating boom will be lowered.
7. **Extend the articulating boom:** Depress the foot switch and push the articulating boom telescope switch upwards – the articulating boom will extend. (if equipped)
8. **Retract the articulating boom:** Depress the foot switch and pull the articulating boom telescope switch downwards – the articulating boom will retract. (if equipped)

## 7.11 PLATFORM MOVEMENTS

<b>WARNING</b>
<p>The platform leveling function can only be used to slightly adjust the platform's levelness in situations such as traveling up/down slopes. Improper use may cause loads/people to move or fall.</p>

### Perform operation from the ground:

1. **Level the platform upward:** Move and hold the enable switch, push upward the platform level switch, the platform will be leveled upward.
2. **Level the platform downward:** Move and hold the enable switch, pull downward the platform level switch, the platform will be leveled downward.
3. **Rotate the platform clockwise:** Move and hold the enable switch, pull downward the platform rotate switch, the platform will rotate clockwise.
4. **Rotate the platform counterclockwise:** Move and hold the enable switch, push upward the platform rotate switch, the platform will rotate counterclockwise.

### Perform operation from the platform:

1. **Level the platform upward:** Depress the foot switch, push the platform level switch upward, the platform will be leveled upward.
2. **Level the platform downward:** Depress the foot switch, pull the platform level switch downward, the platform will be leveled downward.
3. **Rotate the platform clockwise:** Depress the foot switch, push the platform rotate switch to the left, the platform will rotate clockwise.
4. **Rotate the platform counterclockwise:** Depress the foot switch, push the platform rotate switch to the right, the platform will rotate counterclockwise.

## 7.12 HYDRAULIC GENERATOR (IF EQUIPPED)

1. Start the engine and wait for the engine to run at idle speed stably.
2. Stop all the movements of the machine.
3. Turn the ground/platform control selector switch at the ground control position to the Platform control position.
4. Pull out the emergency stop button at the platform control position to the ON position.
5. Depress the foot switch and move the hydraulic generator switch upward to upper position, and the engine will automatically start to run at high speed, and after the engine runs at high speed stably for 5s, the solenoid valve of the hydraulic generator will be energized and start generating electricity.
6. Move the hydraulic generator switch downwards to the OFF position (lower position), and the hydraulic generator will stop generating power.

### For hydraulic generator in Australia configuration:

- When the hydraulic generator is normally started and in the generating state (the "hydraulic generator ON indicator" icon on the turntable display is illuminated), depressing the foot switch will stop the generation, and the "hydraulic generator ON indicator" icon on the turntable display will turn off.
- When the foot switch is released, the hydraulic generator will restart generation, and the "hydraulic generator ON indicator" icon on the turntable display will light up again.
- If the foot switch is depressed for more than 7 seconds, the "No Action within 7s" alarm will be triggered. After releasing the foot switch, the hydraulic generator will not restart generation. It is necessary to depress the foot switch again to cancel the alarm, then release the foot switch, and the hydraulic generator will restart and begin generating power.

This logic does not apply to hydraulic generators in other configurations.

## 7.13 AUXILIARY POWER

<b>NOTICE</b>
<ul style="list-style-type: none"> <li>• <i>When the auxiliary power is in use, do not perform two or more functions at the same time, because certain operations may not respond due to the low voltage in the auxiliary motor or pump.</i></li> <li>• <i>The auxiliary power switch can only be used for a short time (to fully lower and retract the platform from maximum angle/maximum extension) when the main power source is not working, prolonged operation may damage the electric motor.</i></li> </ul>

In the event of main power source failure, the auxiliary power can be used to perform the desired boom actions.

### Perform operation from the ground:

Move and hold the auxiliary power switch, activate the desired boom movement switch to perform the required function operation.

### Perform operation on the platform:

Depress the foot switch, move and hold the auxiliary power switch, and activate the desired boom movement switch to perform the required function operation.

<b>NOTICE</b>
<p><i>The emergency power can't be used to perform travel function.</i></p>

## 7.14 TURNING OFF AND STOPPING

1. Park the machine on a firm, flat, and level surface, and make sure the area is adequately protected.
2. Make sure the boom is fully retracted and positioned above the rear-wheel drive axle, and remove all loads from the platform.
3. If equipped with an engine, idle the engine for 3min - 5min to lower its internal temperature.
4. Press the emergency stop button at the turntable controller and platform controller, turn the key switch to OFF position and remove the key.
5. Close the platform controller guard to protect the platform controller, handles, switches and panels from harsh environments.
6. If the machine is to be left unused for a long time, press the power-off switch.

7. Make sure that all panels and gates are closed and secured.

## 7.15 TRANSPORT AND LIFTING

The mobile elevating work platform is a non-road vehicle and is not licensed for on-road use, so the machine needs to be transported and transferred by road, railway or waterway.

### WARNING

**Only qualified individuals may drive the machine onto or from the transport vehicle.**

Before transporting and lifting the machine:

1. Determine the total weight of the machine (see machine nameplate or **Technical Parameters** section of this manual) and select the appropriate lifting equipment, rigging equipment, and transport vehicle.
2. Make sure the boom is stowed, that the turntable is locked (lock the slewing pin if so equipped), make sure there are no loose or unsecured parts on the machine, and that there are no persons or tools on the platform.

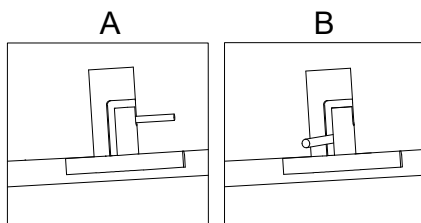

**Fig. 9**

A: The turntable slewing pin is not locked, and the turntable can rotate

B: The turntable slewing pin is locked, the turntable cannot rotate

3. Ensure that the machine lifting points/rigging equipment lashing points and their rigging equipment are

intact and that the belt or rope to be used has sufficient load strength.

4. Before loading/unloading the machine, ensure that the transport vehicle is parked on level ground and that the ramp used for driving the machine onto the transport vehicle does not exceed the maximum gradeability of the machine.
5. When loading/unloading the machine, the transport vehicle must be secured to prevent it from moving.
6. The wheels should be locked after the machine is loaded to prevent it from moving.
7. Before releasing the brake, the machine must be parked on a horizontal surface or secured.
8. The machine may only be lifted from a specific position with a forklift or crane with sufficient lifting capacity. Care should be taken to prevent the machine from colliding with surrounding objects.

## Transport

1. Adjust the machine to the transport position. (the positions of the jib boom and platform in the following figure are for reference only, and can be adjusted as appropriate for the trailer during transportation).
2. Turn the key switch on the turntable controller to the OFF position and remove the key.
3. Firmly secure the chassis on the transport vehicle and take appropriate safety measures. Use at least 4 ropes or belts to secure the chassis and at least 1 rope or belt to secure the platform.
4. Adjust the rigging appropriately to prevent damage to the rope or belt.
5. To protect the boom, platform components and electrical and hydraulic components, do not apply excessive downward pulling force to the ropes or belts used to secure the platform. A cushioning layer/foam layer with a thickness of 200mm must be placed under the platform during transportation, and ensure that the compression deformation of the cushioning layer does not exceed 80mm.

### NOTICE

*After transport to the destination, when starting the machine for the first time, the first step is to manually level the platform. Do not perform boom lifting when the upward leveling cylinder is fully retracted.*

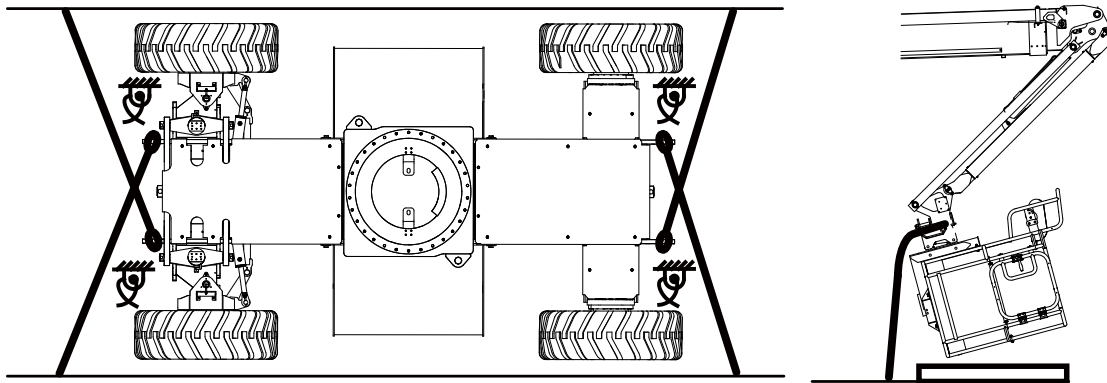

Fig. 10 Transport Diagram

Lifting

1. Determine the center of gravity of the machine.
2. The rigging equipment must be attached to the machine's specified lifting point.
3. Adjust the rigging equipment properly to avoid damage to the machine and keep the machine level.

X=1320 mm (52.0in)      Y=1130 mm (44.5in)

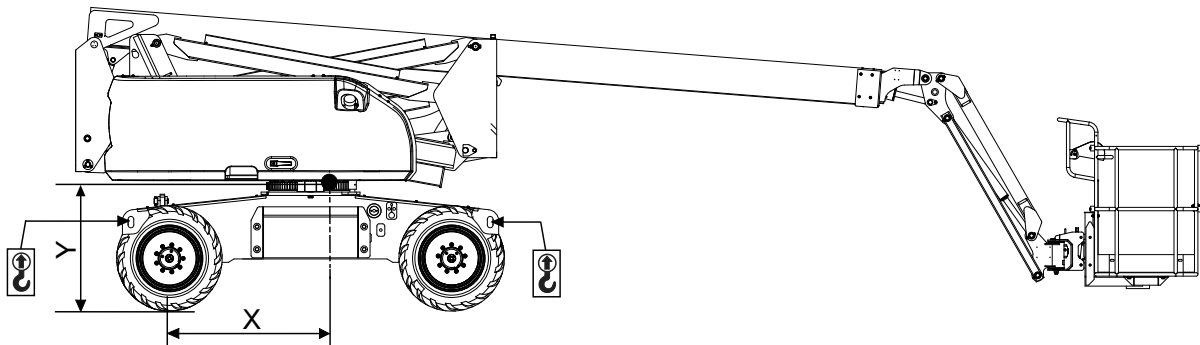

Fig. 11 Center of Gravity and Lifting Diagram

7.16 STORAGE

Mobile elevating work platforms should be stored in places that are protected from rain, humidity, sunlight, or corrosive gases, and that have good ventilation.

In order to ensure the machine can be operated normally after prolonged storage, the following measures should be taken when storing the machine:

1. Retract and lower the boom to the stowed position.
2. Press the emergency stop button at the turntable controller and platform controller, turn the key switch to OFF position and remove the key.
3. Press the power-off switch to OFF.
4. Chock the wheels.
5. Wipe off all dust and oil from the machine to keep it clean.
6. Apply lubricating oil to parts prone to corrosion.
7. For a machine stored for more than three months, the hydraulic oil, fuel oil and coolant should be drained, the positive pole and negative pole of the battery should be disconnected, and insulation protection measures shall be taken.
8. Close and lock all panels and gate locks on the machine.
9. For a machine stored for more than three months, idle the machine every month for not less than one hour each time, and clean and maintain the machine. Please refer to the **Record of Antirust Operation during Storage** for the operating items.
10. For a machine stored for more than one and a half years, a comprehensive inspection and maintenance on the machine should be carried out before use, aging seals and filter elements should be replaced as appropriate.

Table 7-2 Record of Antirust Operation during Storage

Record of Antirust Operation during Storage					
Model		Ex-factory number		Inspection date	
No.	Inspection item	Operating standard		Inspection results	Notes
1	Fuel level check	Fill the diesel tank to 20-25 % capacity.			
2	Hydraulic oil level	The oil level shall be at the middle-upper position of level gauge (stowed position).			
3	Engine starting	Press the engine start switch, the engine shall start smoothly without any abnormal noises.			
4	Speed measurement while running at idle speed	Measure the speed after idling for 5 minutes Cummins: 1000 ± 50 rpm; Others: 1200 ± 50 rpm			
5	Speed measurement while running at low speed	Measure the speed after running at low speed for 2 minutes (1500 ± 50 rpm)			
6	Speed measurement while running at high speed	Measure the speed after running at high speed for 2 minutes (2200 ± 50 rpm)			
7	Engine oil level	After the engine has stopped for 15 minutes, the oil level shall be between the L mark and H mark on the dipstick.			
8	Platform rotation	At low engine speed, rotate the platform counterclockwise and clockwise, each for 2 cycles. The whole process shall be smooth with no rattling.			
9	Level the platform	At low engine speed, level the platform upwards and downwards, each for 2 cycles. No lagging or shaking shall be observed during leveling.			
10	Jib lifting/lowering	At low engine speed, lift and lower the jib, each for 2 cycles. The whole process shall be smooth with no rattling.			
11	Main boom lifting/lowering	With the boom fully retracted, and the engine at low speed, perform main boom lifting and lowering, each for 2 times. The boom shall have no shaking or rattling throughout.			
12	Main boom telescoping	With the boom lifted to its maximum angle, and the engine at low speed, perform main boom extending and			

**Table 7-2 Record of Antirust Operation during Storage (continued)**

<b>Record of Antirust Operation during Storage</b>				
		retracting, each for 2 times. The boom shall have no shaking or rattling throughout.		
13	Turntable slewing	With the boom fully retracted and lifted to its maximum angle, and the engine at low speed, slew the turntable for 2 circles. The whole process shall be smooth with no rattling.		
14	Travel	In the non-operating position, drive at the maximum travel speed for 50 meters (164 ft). The start of traveling should be free of shocks, and the travel process must be smooth.		
15	Oil leakage check	Check the hydraulic pipelines, mating surfaces of hydraulic components, and fittings for any oil leakage.		
16	Appearance check	Check the painted surfaces for scratches, bubbles, and other defects, and inspect all components and standard parts for signs of rust.		

**This Page Intentionally Left Blank**

# 8

## EMERGENCY PROCEDURES

This chapter describes the steps to follow in the event of unexpected situations during operation.

### 8.1 REPORTING ACCIDENTS

In case of any accident involving Hunan Sinoboom Intelligent Equipment Co., Ltd. products, Hunan Sinoboom Intelligent Equipment Co., Ltd. must be notified immediately. In case of any accident involving the machinery of Hunan Sinoboom Intelligent Equipment Co., Ltd., notify Hunan Sinoboom Intelligent Equipment Co., Ltd. by telephone immediately and provide all necessary details, even if the accident did not cause personal injury or property damage.

Failure to notify the manufacturer within 48 hours of the incident involving the machinery of Hunan Sinoboom Intelligent Equipment Co., Ltd. may void the product warranty.

#### NOTICE

*Thoroughly inspect the machine and all its functions after any accident. First, test all functions from the ground controller, then from the platform controller. Ensure the machine's lifting height does not exceed 3 m (10 ft) until all damage has been repaired and all controllers operate properly.*

### 8.2 EMERGENCY OPERATION

**When the operator is unable to control the machine (squeezed or trapped on the platform):**

1. Other personnel can only operate the machine from the turntable controller according to the operation requirements.
2. Other qualified personnel on the platform can operate the platform controller. If the controller is not working properly, do not continue to operate.
3. Hoists, forklifts or other equipment that meet the requirements of use can be used to transport people on the platform and stabilize the movement of the machine.

**When the platform or boom is stuck at height:**

If the platform or boom is stuck or blocked by a high building or aerial equipment, rescue the operator on the platform first before attempting to free the machine.

**If any switch is reset but the movement does not stop:**

If any switch/handle returns to neutral position and the corresponding movement does not stop, remove the foot from the foot switch or push in the emergency stop button to stop the machine.

### 8.3 EMERGENCY LOWERING

When the main power source fails, the auxiliary power on the turntable controller or platform controller can be used according to the actual condition to lower the platform into place. Refer to the **Auxiliary Power** section for detailed procedures.

## 8.4 EMERGENCY TOWING

### WARNING

- Except in case of emergency situations, machine malfunction, power loss or loading/unloading, it is strictly prohibited to tow or drag the machine.
- When towing or dragging the machine, comply with local policies and road traffic regulations.
- Towing the machine on public highways is prohibited.
- The machine is not equipped with a brake for towing control, so the towing vehicle must be able to control the machine at all times, otherwise the machine may lose control, resulting in serious injury or death.
- The maximum permissible towing speed is 3 km/h (1.9 mph).
- The maximum permissible towing gradient is 25 %.
- The machine cannot be towed to move for a long time. Each continuous towing time should not exceed 30 minutes.
- Continuous high-speed travel of the machine for a long time can cause the gear oil temperature inside the drive reducer to become too high, which may damage the seal and lead to oil leakage. To prevent this situation, the continuous high-speed travel time of the machine shall not exceed 30 minutes.
- The machine must not be towed/dragged when the brake has not been released or the machine is started.
- Before the brake is released, the machine must be parked on a horizontal surface or secured.

1. Place the machine on firm and level ground and secure the wheels with chocks to prevent the machine from moving inadvertently.
2. Make sure that the machine is stowed, that the turntable is locked (or if equipped with turntable slewing pin, that the turntable slewing pin is locked), that there are no loose or unsecured parts on the machine, that there are no persons or tools on the platform, and that there are no obstacles on the surrounding area.
3. Loosen the bolts of disconnect cap on the side of drive reducer, and then install the disconnect cap in the reverse position.

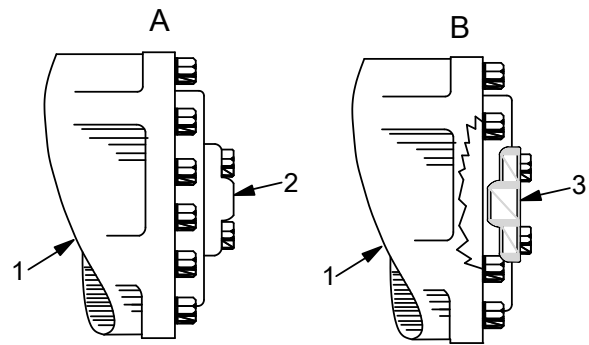

Fig. 1

A Normal position - engaged

B Reverse position - disengaged

- 1) Drive reducer
- 2) Disconnect cap (normal position)
- 3) Disconnect cap (reverse position)
4. Tighten the bolts, the brake is separated, the brake is released, the machine can be towed or dragged by an external force.
5. After towing, place the machine on firm and level ground and secure the wheels with chocks to prevent the machine from moving.
6. Reinstall the disconnect cap to the side of drive reducer in the normal position.

## 8.5 OVERRIDE OPERATION WITH AN OVERLOADED PLATFORM

The function “override operation with an overloaded platform” is only available for certain overseas models.

With the machine in the overweight limit (KG) mode, if an overload alarm is triggered and the platform needs to be lowered, the function override operation with an overloaded platform should be activated.

- Perform operation from the ground: Activate the desired movement switch while operating the auxiliary power switch on the turntable controller;
- Perform operation on the platform: Depress the foot switch, move the emergency power switch on the platform controller, and activate the desired movement switch.

This will activate the function override operation with an overloaded platform, and the corresponding movement can be performed. The time of the override operation and the actual weight on the platform are shown on the display and are recorded.

**NOTICE**

The function override operation with an overloaded platform may only be used to lower the platform in an emergency situation when the platform is overloaded. Before operating the machine using the override function make sure that the surrounding area is safe/clear and the machine is in a safe state.

**WARNING**

When using the function override operation with an overloaded platform avoid movements in directions where the machine may tip over. Improper operation may cause the machine to tip over, causing injuries to personnel and severe damage.

**8.6 OPERATOR PROTECTIVE OPERATION**

While the operator operates the machine from the platform, accidents caused by involuntary operation of the platform controller may occur. The operator protective device can disable all functions of the platform control panel and activate the strobe light to warn the operator in case of inadvertent operation.

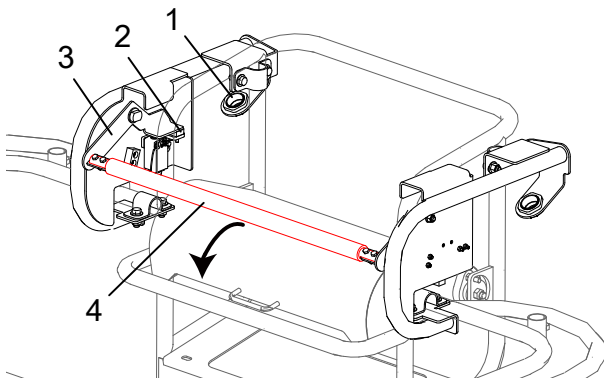

Fig. 2

No.	Description
1	Strobe light
2	Magnet
3	Folded plate
4	Round rod

1. When the operator protective device is not triggered, the position of the round rod is as shown in

the diagram above, with the angle brackets on the left and right sides being attracted by the magnet below.

2. If the round bar is pressed down, the angle brackets on both sides detach from the magnets and flip up, the travel switch will disconnect, the left and right strobe lights will flash, and all functions on the platform controller will be disabled. The machine can be restored to operation using the following two methods:

- Depress the foot switch while operating the release switch on the platform controller – the boom may be retracted and lowered, and the turntable may rotate slowly.
- Lift the round bar up until the angle brackets on both sides are attracted by the magnet again. Then, the strobe light will turn off, and the machine will resume all operations (ensure the machine is in a safe position before performing this operation).

**WARNING**

The operator protective device and other attachments installed on the platform will affect the load capacity of the platform; this must be factored into the total platform capacity.

**This Page Intentionally Left Blank**

# 9

# DECALS DIAGRAM

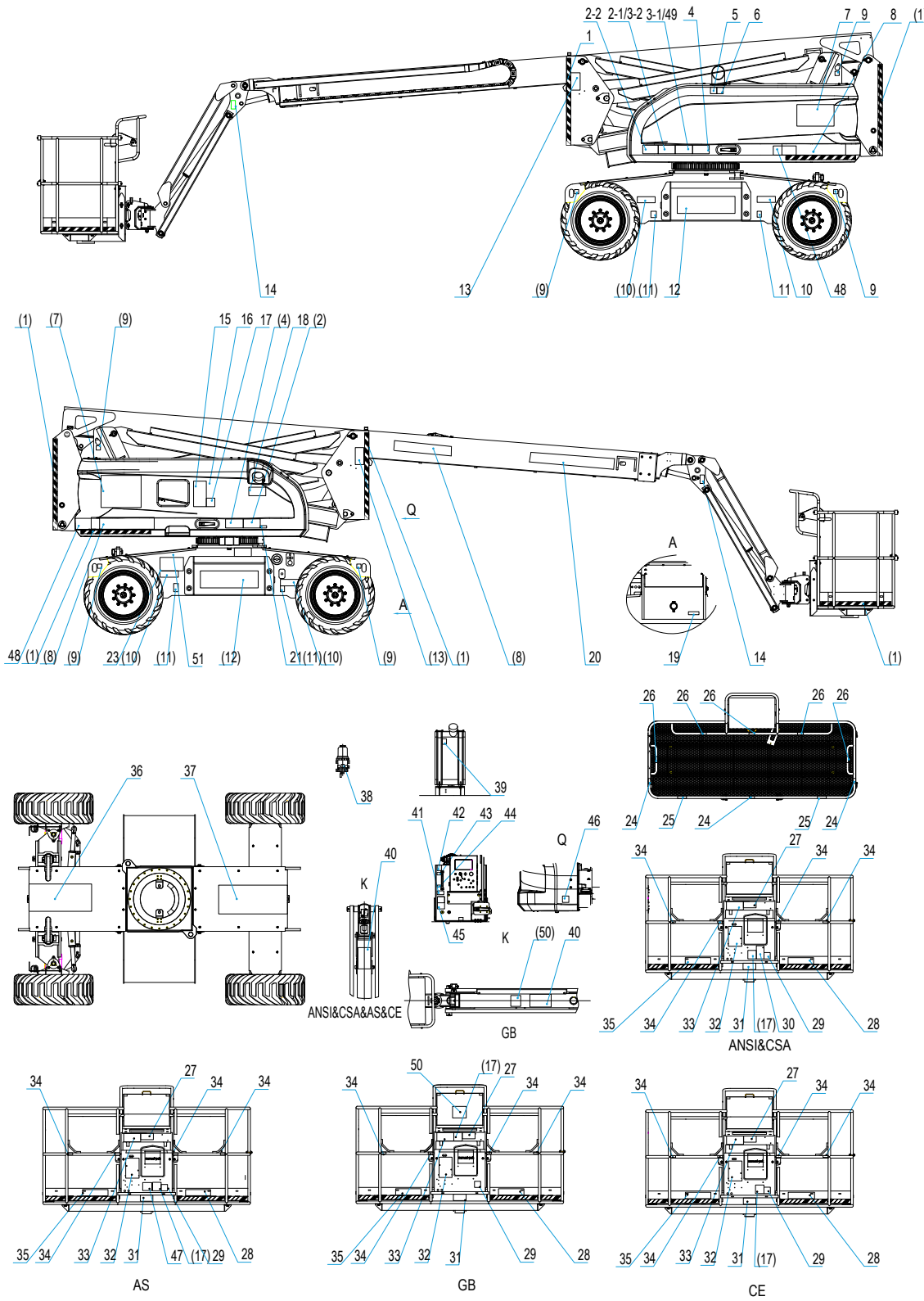

No.	ANSI & CSA	AS	CE - Metric	CE - Imperial	GB	Description	Quantity
	104029100014	104029100008	104029100012	104029100003	104029100013	General decals diagram	1
1	216060000002	216060000002	216060000002	216060000002	216060000002	Yellow & black hazard warning tape w. stripes	9
2-1	104011100013	104011100013	104011100013	104011100013	/	Decal – Electrocutation hazard	2
2-2	/	/	/	/	104011100013	Decal – Electrocutation hazard	2
3-2	104011100005	104011100005	104011100005	104011100005	/	Decal – Explosion hazard	1
3-2	/	/	/	/	104011100005	Decal – Explosion hazard	1
4	104011100006	104011100006	104011100006	104011100006	104011100006	Decal - General maintenance	2
5	105064103023	105064103023	105064103023	105064103023	105064103023	Decal - Burn hazard	1
6	104023103026	104023103026	104023103026	104023103026	104023103026	Decal - Noise 104 dB	1
7	103008103006	103008103006	103008103006	103008103006	103008103006	LOGO Symbol (small)	2
8	104032100008	104032100009	104032100009	104032100008	104032100009	Decal - Trade name	3
9	104011100002	104011100002	104011100002	104011100002	104011100002	Decal – Lifting point	6
10	104011100001	104011100001	104011100001	104011100001	104011100001	Decal – Tipping hazard	4
11	104032100011	104032100011	104032100011	104032100011	104032100011	Decal – Ground pressure	4
12	114011100003	114011100003	114011100003	114011100003	105084100018	Decal – Contact information (including website)	2
13	104011100011	104011100011	104011100011	104011100011	104011100011	Decal – Crushing hazard	2
14	103009103009	103009103009	103009103009	103009103009	103009103009	Decal – Crushing hazard	2
15	104011100020	104011100020	104011100020	104011100020	104011100020	Decal – General safety instructions	1
16	104023103025	104023103025	104023103025	104023103025	104023103025	Decal - Emergency lowering (AB)	1
17	103011103021	103011103021	103011103021	103011103021	103011103021	Decal – Tipping hazard	2
18	104011100014	104011100014	104011100014	104011100014	104011100014	Decal – Explosion hazard	1
19	101014100032	101014100032	101014100032	101014100032	101014100032	Decal – Machine serial number	1
20	105058103003	105058103003	105058103003	105058103003	114015103036	LOGO-SINOBOOM (small)	1
21	101040103015	/	/	/	/	Decal – Annual inspection date	1
22	104011100022	104011100022	104011100022	104011100022	104011100022	Decal - Turntable stewing pin	1

No.	ANSI & CSA	AS	CE - Metric	CE - Imperial	GB	Description	Quantity
23	215050000012	215050000012	215050000012	215050000012	215050000012	Blind rivet 4x8-ZnD GB/T 12618.2	4
24	103010103014	/	/	/	/	Decal – Non-insulated	3
25	104011100021	104011100021	104011100021	104011100021	104011100021	Decal – Crushing hazard	2
26	101079103034	101079103034	101079103034	101079103034	101079103034	Decal – Handle hold position	5
27	104011100009	104011100009	104011100009	104011100009	104011100009	Decal – Refer to the manuals	1
28	103009103013	103009103013	103009103013	103009103013	103009103013	Decal - Rated platform capacity	1
29	105064103022	105064103022	105064103022	105064103022	105064103022	Decal – Foot switch	1
30	103006103003	/	/	/	/	Decal – Operation instructions	1
31	104011100019	104011100019	104011100019	104011100019	104011100019	Decal – Crushing hazard	1
32	104032100010	104032100010	104032100010	104032100010	104032100010	Decal – Working envelope diagram	1
33	105021100003	105021100003	105021100003	105021100003	105021100003	Decal – Tipping hazard	1
34	103006103014	103006103014	103006103014	103006103014	101048100014	Decal – Anchorage point	4
35	103007103002	103007103002	103007103002	103007103002	103007103002	Decal – Tipping hazard	1
36	105001100053	105001100053	105001100053	105001100053	105001100053	Decal – Direction marking	1
37	105001100051	105001100051	105001100051	105001100051	105001100051	Decal – Direction marking	1
38	104009100020	104009100020	104009100020	104009100020	104009100020	Decal – Fuel-water separator	1
39	102012103008	102012103008	102012103008	102012103008	104009100019	Decal – Diesel fuel marking	1
40	104011100012	104011100012	104011100012	104011100012	104011100012	Decal – Fall hazard	1
41	104010100021	104010100021	104010100021	104010100021	104010100021	Decal – Applicable temperature range	1
42	102012103009	102012103009	102012103009	102012103009	104009100018	Decal – Hydraulic oil marking	1
43	104011100010	104011100010	104011100010	104011100010	104011100010	Decal – Hydraulic oil level	1
44	104011100003	104011100003	104011100003	104011100003	104011100003	Decal – Hydraulic oil level	1
45	105084100019	/	/	/	/	Decal – Hydraulic oil selection description	1
46	115008100017	104024103001	115008100017	115008100017	115008100017	Decal – Emergency stop button	1

No.	ANSI & CSA	AS	CE - Metric	CE - Imperial	GB	Description	Quantity
47	/	105068103022	/	/	/	Decal – Generator start instructions	2
48	/	/	/	/	103012100016	Decal – Sinoboomb	2
49	/	/	/	/	103013100016	Decal – IPAF	1
50	/	/	/	/	103010103047	Decal - Platform must not touch the ground	2
51	/	/	/	/	Environmental information code marking position	/	/

# 10 MAINTENANCE

Your machine must receive regular maintenance to ensure it remains in good condition. This chapter provides the operator with additional information needed to properly operate and maintain the machine, and is only intended to assist the operator in performing routine maintenance tasks. For more comprehensive maintenance instructions, please refer to the **Inspection and Preventive Maintenance Schedule** and the Maintenance Manual.

## 10.1 LUBRICATION

In order to ensure the performance and service life of the machine and its components, moving parts must be regularly inspected and lubricated.

NOTICE
<ul style="list-style-type: none"> <li>• <i>Mixing lubricating oil of different grades will alter its properties and cause damage to the machine. When refilling lubricant, the oil being added must be of the same grade as the oil currently in use in the machine.</i></li> <li>• <i>Any contamination (dust) of the lubricating oil can lead to premature wear of the sliding surfaces and shorten the service life of the machine. Before adding lubricating oil the container used for filling and other surfaces must be cleaned.</i></li> <li>• <i>Failing to adhere to lubrication cycles or lack of lubrication can cause equipment damage, and increase repair costs and downtime.</i></li> </ul>

 WARNING
<ul style="list-style-type: none"> <li>• <b>During the lubrication procedure, non-related personnel are prohibited from operating the equipment. Unexpected equipment movements could pose serious risks to the operator.</b></li> <li>• <b>If lubricating oil gets into the eyes, rinse the eyes immediately with clean water and seek medical attention promptly. If the skin comes into contact with lubricating oil, make sure to thoroughly wash the skin with water.</b></li> </ul>

Table 10-1

No.	Position	Interval	Lubricating oil/grease grade	Operation
1	Travel drive device	Every 3 months or 250 operating hours	Refer to the <b>Gear Oil</b> section	Check oil level
		Every 1 year or 1000 operating hours		Replace oil
2	Slewing drive unit	Every 3 months or 250 operating hours	Refer to the <b>Gear Oil</b> section	Check oil level
		Every 1 year or 1000 operating hours		Replace oil
3	Slewing bearing	Every 3 months or 250 operating hours	ZL-3 lithium-based lubricating grease	Add oil with oil gun
4	Cylinder (if equipped with grease nipple)	Every 3 months or 250 operating hours	ZL-4 lithium-based lubricating grease	Add oil with oil gun

Table 10-1 (continued)

No.	Position	Interval	Lubricating oil/grease grade	Operation
5	Parts that move relative to one another	Every 3 months or 250 operating hours	ZL-5 lithium-based lubricating grease	Add oil with oil gun
Note: If the machine is equipped with an integrated slewing bearing (including both the slewing drive unit and the slewing bearing) to perform the slewing movement, just conduct an inspection and lubrication as per requirement No. 1, 3, 4, 5 in the table.				

Lubrication intervals are based on machine usage under normal operating conditions. If the machine is used in rough (such as dusty environments) or other unusual conditions, inspection and lubrication should be performed more frequently.

### Hydraulic Oil

Factory-filled hydraulic oil is usually based on the ambient temperature of the delivery place or as specified by customers. If the factory-filled hydraulic oil is not applicable for the machine operating environments, change to other hydraulic oil suitable for actual operating environment. The following table shows the recommended hydraulic oil grade for different ambient temperature ranges:

Table 10-2

Ambient temperature range	Hydraulic oil grade
> 40°C (104°F)	HM-68
0°C – 40°C (32°F – 104°F)	HM-46
-15°C – 25°C (5°F – 77°F)	HV-32
-22°C – 25°C (-7.6°F – 77°F)	L-HS32
< -22°C (-7.6°F)	AE-VX

## 10.2 OIL SPECIFICATIONS

### NOTICE

- Please choose suitable oil according to the ambient temperature and local regulations; the use of unsuitable oil will damage the machine components.
- Oils of different grades or viscosities should not be mixed. When refilling oil, the oil being added must be of the same grade and viscosity as that of the oil currently in use in the machine.
- To fill with oil with a different grade or viscosity, the remaining oil in the circuit must be drained out completely.
- The oil recommendations in this manual are for general operating conditions. For special environments or special operating requirements please contact Sinoboom for special oil.

### WARNING

- Before refilling oil, wait until the temperature of the machine drops to room temperature, otherwise it may cause splashes, burns or other personal injury.
- The use of inferior oils is strictly prohibited. Using inferior oil may damage the machine, and faults caused by this are not covered by Sinoboom’s warranty.

### Gear Oil

This machine is filled with heavy-duty vehicle gear oil (GL-5). Choose the oil viscosity grade that suits your region’s ambient temperature. The following table shows the recommended ambient temperature for different viscosity grades of gear oil:

Table 10-3

Viscosity grade	Recommended ambient temperature
75W-90	-35 – 40°C (-31 – 104°F)
80W-90	-25 – 40°C (-13 – 104°F)

Note: Sinoboom recommends Mobil gear oil.

Fuel Oil

Table 10-4

**⚠ WARNING**

- The machine should be refueled in a well-ventilated place with no flames, sparks, and other hazards that may cause fire or explosion.
- Do not refuel the machine while the engine is running.

Grade	Recommended ambient temperature
0#	0 – 40°C (32 – 104°F)
-35#	-30 – 25°C (-22 – 77°F)

This machine uses diesel oil as the fuel, and only a small amount of diesel oil is left in the fuel tank when the machine leaves the factory. The user needs to fill diesel oil timely with appropriate grade according to the ambient temperature and emission regulations. The following table shows the recommended ambient temperature for different grades of diesel oil:

**NOTICE**

*Please go to a certified gas station to purchase qualified fuel oil. It is recommended prepare an oil storage tank with fuel filter and store the fuel oil in the tank for more than two days to precipitate impurities and water before use.*

Engine Oil

Engine oil should be selected based on the engine type and the local ambient temperature. The table below shows the recommended engine oil for different types of engine:

Table 10-5

Engine type	Recommended service category*	Recommended viscosity grade**
Engines meeting China III emission standards	CH-4	5W-40/15W-40
Yanmar engines meeting China III emission standards	CJ-4	5W-40/15W-40
Engines meeting China IV, Euro V and EPA Tier 4 emission standards	CJ-4/CK-4	5W-40/15W-40

\* The letters “H”, “J” and “K” represent engine oil service category, and the oil specifications become more severe as the letters climb the alphabet. Select engine oil according to the recommendations in the table above, at least not below the service category of oil recommended in the table.

\*\*The number before the “W” indicates the oil’s fluidity at low temperatures, and subtracting 35 from it gives the minimum ambient temperature for use. For example, the minimum ambient temperature for use of 15W oil is -20°C (-4°F). Choose the oil viscosity grade according to your region’s lowest ambient temperature.

Antifreeze

Factory-filled antifreeze is based on engine brand:

Table 10-6

Engine brand	Antifreeze type
Deutz	-45°C antifreeze
Yanmar	-40°C antifreeze
Other brands (except Deutz, Yanmar)	-35°C antifreeze

The antifreeze types above could meet the requirements of areas with ambient temperature above -35°C (-31°F). If the machine is to be operated in environments with temperature below -35°C (-31°F), contact Sino-boom for appropriate antifreeze.

10.3 TIRE ASSEMBLY

**NOTICE**

*Non-marking tires shall be used indoor only on ground sufficient to support the total mass of the machine (machine weight + platform load).*

## Check Tires and Rims

Check the tires and rims daily and replace a tire if any of the following defects is found:

- The tire is severely cracked, broken, deformed or shows other abnormalities.
- The tire ply shows a smooth, uniform cut with a total length of more than 75 mm (3 in).
- The tire ply shows a crack or fissure that exceeds 25 mm (1 in) in either direction.
- The tire has a puncture with a diameter of more than 25 mm (1 in).
- The tire shows severe bulging.
- The wear extent of the tire's ground-supporting surface exceeds 25 %.

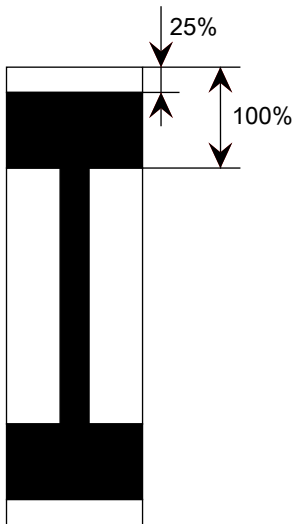

Fig. 1

## Check Wheel Nuts

The wheel nuts should be tightened before the machine is put into service for the first time and after each tire is removed. Check and tighten the wheel nuts to the specified torque every 3 months or 250 operating hours.

## Replacement Requirements

### WARNING

- **The tires and rims on the machine have been designed and selected according to the overall performance and load stability requirements of the machine. Therefore, the model specifications, rim width, installation center surface, diameter, etc. must not be changed, otherwise this could lead to an unstable and hazardous condition.**
- **Wheel-specific nuts must be used that match the wheel bolts. The wheel nuts must be installed and maintained with the proper tightening torque to prevent loose rims, broken bolts and wheels loosening from the axle. Be sure to only use nuts that match the mounting angle of the rim holes.**

Hunan Sinoboom Intelligent Equipment Co., Ltd. recommends the replacement tire be of the same size, ply rating and brand as the original tire. For the tire part numbers of specific machine models, please refer to the Parts Manual of the corresponding machine. If you choose not to use the replacement tires recommended by Hunan Sinoboom Intelligent Equipment Co., Ltd., the following specifications should be adhered to:

- The ply rating/rated load capacity and size should be the same as the original tire or superior to it.
- The tire tread contact width should be the same as or superior to the original tire.
- The wheel diameter, width and offset dimensions must be the same as the original tires.
- The replacement tire must be approved for the application by the tire manufacturer (including intended purpose, maximum travel speed, maximum tire load, etc.).
- Due to size differences between different tire brands, both tires on the same axle should be of the same brand.

### NOTICE

*Unless specifically approved by Sinoboom, do not replace foam-filled tires with pneumatic tires.*

## Replace Tire and Wheel Assembly

 **WARNING**

**Tighten the wheel nuts to the specified torque to prevent the wheel from loosening. Use a torque wrench to tighten the nuts. If no torque wrench is available use a socket wrench to tighten the nuts and then immediately have a service station or dealer tighten the nuts to the specified torque. Over-tightening will cause the nuts to break or permanently deform the bolt holes in the rims.**

The correct steps to replace a tire and wheel assembly are as follows:

1. Make sure the machine is in stowed position.
2. Turn the power switch off and disconnect all power sources (such as battery charger) from the machine. If the machine is equipped with high-voltage lithium batteries, the lithium battery service switch needs to be disconnected.
3. Use a wrench to loosen but do not remove the wheel nuts yet.
4. Use a jack with sufficient load capacity to lift the frame to an appropriate height so that the tire and wheel assembly is off the ground.
5. Remove the wheel nuts in an alternating sequence, then remove the tire and wheel assembly.
6. Align the mounting holes of the new tire and wheel assembly with the corresponding mounting holes on the drive reducer.
7. Apply Loctite 272 thread locking adhesive to the bolts and nuts, then install the nuts in sequence.
8. Tighten all nuts by hand first to prevent loosening of the bolts and nuts. Never apply lubricant to threads or nuts.
9. Then tighten the nuts step by step in the sequence as shown below. Please refer to the recommended torque settings in the table below.

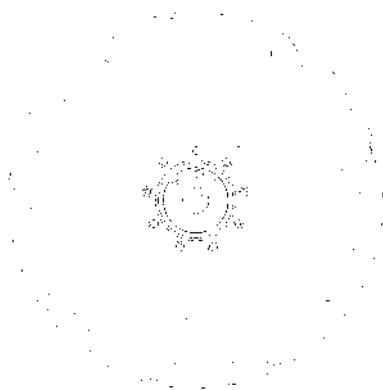

Fig. 2 Diagram – Wheel Nuts Tightening Sequence

Table 10-7 Table of Wheel Nuts Tightening Torque

First step	Second step	Third step
150 Nm (110 ft-lb)	240 Nm (177 ft-lb)	300 Nm (221 ft-lb)

## 10.4 INSPECTION AND PREVENTIVE MAINTENANCE SCHEDULE

This section provides safety and other vital information for machine operators. To extend the service life of the machine and ensure safe operation, all necessary inspections and maintenance work must be completed before the machine is put into service.

It is crucial to develop and adhere to a comprehensive inspection and preventive maintenance program. This manual outlines the regular inspections and maintenance procedures recommended by Hunan Sinoboom Intelligent Co., Ltd. Consult your national, regional or local regulations for aerial work platforms. The frequency of the inspection and maintenance must be increased as required by environmental conditions, requirements and frequency of usage.

### Pre-delivery Inspection

The pre-delivery inspection shall be performed by qualified Sinoboom technicians.

A pre-delivery inspection shall be performed before each sale, lease or rental delivery.

Refer to the **Inspection and Preventive Maintenance Schedule** for items requiring a pre-delivery inspection. Refer to the corresponding section of this manual to perform inspection and maintenance procedures.

### Pre-operation Inspection

A pre-operation inspection must be performed before each start or restart of work, change of operator, and after each maintenance operation. Refer to the pre-operation inspection section of the Operation Manual for detailed information. The Operation Manual must be entirely read and understood before performing the pre-operation inspection.

### Regular Inspections

Regular inspections shall be performed by qualified Sinoboom technicians.

Regular inspections must be performed after the machine has been in service for 3 months or 250 hours, whichever comes first, or if it has been out of service for more than 3 months. The frequency of the inspection and maintenance must be increased as required by environmental conditions, requirements and frequency of usage.

The items included in the regular inspections are identical to the pre-delivery inspection.

## Annual Inspection

An annual machine inspection must be performed once a year and no later than 13 months from the date of the previous annual inspection. Hunan Sinoboom Intelligent Equipment Co., Ltd. recommends this task be performed by a factory-trained service technician, a person recognized by Sinoboom as one who, by qualification, certificate and training, has successfully demonstrated the ability and proficiency to service, repair and maintain the Sinoboom model in question.

Refer to the **Inspection and Preventive Maintenance Schedule** for items requiring annual inspection, and refer to the corresponding section of this manual to perform inspection and maintenance procedures.

## Preventive Maintenance

Preventive maintenance procedures shall be performed by qualified Sinoboom technicians. The frequency of the inspection and maintenance must be increased as required by environmental conditions, requirements and frequency of usage.

Refer to the **Inspection and Preventive Maintenance Schedule** for items requiring a preventive maintenance. Refer to the corresponding section of this manual to perform inspection and maintenance procedures.

## Responsible Persons and Qualifications for Performing Inspection and Maintenance

Table 10-8

Inspection Type	Inspection Frequency	Primary Responsible Persons	Service Qualifications
Pre-operation Inspection	Before starting/restarting work, change of user, after each maintenance activity.	User or operator	Properly trained user or operator
Pre-delivery Inspection	Before each sale, lease or rental delivery	Owner, dealer or user	Qualified Sinoboom technician
Regular Inspections	In service for 3 months or 250 hours (whichever comes first) or out of service for more than 3 months	Owner, dealer or user	Qualified Sinoboom technician
Annual Inspection	Once a year and no later than 13 months from the date of the previous annual inspection	Owner, dealer or user	Factory-trained service technician
Preventive Maintenance	At intervals specified in the <b>Inspection and Preventive Maintenance Schedule</b>	Owner, dealer or user	Qualified Sinoboom technician

## Inspection and Preventive Maintenance Schedule

Perform inspection and preventive maintenance for the items in the table below at the specified intervals. Maintenance and inspection intervals are calculated based on the months of service or the “accumulated operating hours” displayed on the turntable controls (whichever comes first).

Inspection intervals are based on the use of the machine under normal operating conditions. The intervals should be shortened accordingly when operating in harsh environmental conditions.

**Table 10-9 Inspection and Preventive Maintenance Schedule**

Item	Interval		
	Before each delivery <sup>1</sup> or quarterly <sup>2</sup>	Semiannually <sup>3</sup>	Annually <sup>4</sup>
<b>Chassis assembly</b>			
Chassis	2	2	2
Tires	1, 2	1, 2	1, 2
Wheel nuts	1 <sup>50</sup>	1 <sup>50</sup>	1 <sup>50</sup>
Drive motor	1, 6	1, 6	1, 6
Drive reducer	1, 2, 6	1, 2, 6	1, 2, 6, 11
Steering components	1, 2	1, 2	1, 2
Axles/extending axles (if equipped)	1, 2, 3	1, 2, 3	1, 2, 3
Bearings	1, 2, 5, 12	1, 2, 5, 12	1, 2, 5, 12
<b>Turntable assembly</b>			
Turntable	2	2	2
Slewing bearing or slewing reducer	1 <sup>50</sup> , 2, 6, 12	1 <sup>50</sup> , 2, 6, 12	1 <sup>50</sup> , 2, 6, 8, 12
Slewing reducer (if equipped)	1, 2, 6	1, 2, 6	1, 2, 6, 11
Central rotary joint	6	6	6
Slewing motor	1, 6	1, 6	1, 6
Turntable slewing pin (if equipped)	1, 2, 3	1, 2, 3	1, 2, 3
Turntable cover assembly	1, 2, 3	1, 2, 3	1, 2, 3
Hydraulic generator (if equipped)	1, 3, 6, 10 <sup>NO.1</sup>	1, 3, 6, 10 <sup>NO.1</sup>	1, 3, 6, 10 <sup>NO.1</sup>
<b>Boom assembly</b>			
Boom weldment	1, 2	1, 2	1, 2
Hose, wire rope bracket	1, 2	1, 2	1, 2
Pulley and wear pad assembly	1, 2	1, 2	1, 2
Bearings	1, 2, 5, 12	1, 2, 5, 12	1, 2, 5, 12
Cover or protective guard (if equipped)	1, 2	1, 2	1, 2
Cable track or wire rope system (if equipped)	1, 2, 3, 5	1, 2, 3, 5	1, 2, 3, 5
Pivot pins and retaining rings	1, 2	1, 2	1, 2
<b>Platform assembly</b>			
Guardrails	2	2	2
Access gate	1, 2, 3	1, 2, 3	1, 2, 3
Floor	2	2	2
Swing cylinder	1, 2, 5, 6	1, 2, 5, 6	1, 2, 5, 6
Safety belt anchorage point	1, 2, 7	1, 2, 7	1, 2, 7

**Table 10-9 Inspection and Preventive Maintenance Schedule (continued)**

Item	Interval		
	Before each delivery <sup>1</sup> or quarterly <sup>2</sup>	Semiannually <sup>3</sup>	Annually <sup>4</sup>
<b>Power system</b>			
Refer to the machine's maintenance manual for inspection and preventive maintenance schedule, and the engine manual provided with the machine for detailed instructions.			
<b>Hydraulic system</b>			
Hydraulic pump	1, 2, 6	1, 2, 6	1, 2, 6
Hydraulic cylinder	1, 2, 5, 6	1, 2, 5, 6	1, 2, 5, 6
Bleeding the oscillating cylinder (if equipped)	10 <sup>NO.1</sup>	10 <sup>NO.1</sup>	10 <sup>NO.1</sup>
Hydraulic valves	1, 2, 5, 6	1, 2, 5, 6	1, 2, 5, 6
Counterbalance valve, check of the locking function (if equipped)	10 <sup>NO.1</sup>	10 <sup>NO.1</sup>	10 <sup>NO.1</sup>
Hydraulic hoses, pipelines and fittings	1, 2, 6	1, 2, 6	1, 2, 6
Hydraulic tank	1, 2, 3, 5, 6	1, 2, 3, 5, 6	1, 2, 3, 5, 6
Hydraulic tank suction filter	1, 5, 6	1, 5, 6	1, 5, 6, 11
Hydraulic tank return filter	1, 5, 6, 11 <sup>50</sup>	1, 5, 6, 11 <sup>50</sup>	1, 5, 6, 11 <sup>50</sup>
Hydraulic tank air filter	1, 5, 6	1, 5, 6, 11	1, 5, 6, 11
Hydraulic oil high-pressure filter	1, 5, 6, 11	1, 5, 6, 11	1, 5, 6, 11
Hydraulic oil	5, 6	5, 6	5, 6, 11
<b>Electrical system</b>			
Electrical harness, connectors	1, 2	1, 2	1, 2
Battery	1, 2, 6, 9, 12	1, 2, 6, 9, 12	1, 2, 6, 9, 12
Electrolyte	6	6	6
Charging function	3	3	3
Instruments, gauges, switches, lamps, horn, contactor, relay	1, 3	1, 3	1, 3
<b>Functions and controls</b>			
Platform controller	1, 3, 4, 7, 10	1, 3, 4, 7, 10	1, 3, 4, 7, 10
Turntable controller	1, 3, 4, 7, 10	1, 3, 4, 7, 10	1, 3, 4, 7, 10
Function control lock, secondary guarding device and brake	1, 3, 10	1, 3, 10	1, 3, 10
Foot switch	1, 3, 10	1, 3, 10	1, 3, 10
Emergency stop button (ground and platform)	1, 3, 10	1, 3, 10	1, 3, 10
Limit switches and power-off switch	1, 3, 10	1, 3, 10	1, 3, 10

**Table 10-9 Inspection and Preventive Maintenance Schedule (continued)**

Item	Interval		
	Before each delivery <sup>1</sup> or quarterly <sup>2</sup>	Semiannually <sup>3</sup>	Annually <sup>4</sup>
Pothole protection device (if equipped)	1, 3, 10	1, 3, 10	1, 3, 10
Overload limit system	1, 3, 10	1, 3, 10	1, 3, 10
Tilt alarm	1, 3, 10	1, 3, 10	1, 3, 10
Drive brake	1, 3, 10	1, 3, 10	1, 3, 10
Slewing brake	1, 3, 10	1, 3, 10	1, 3, 10
<b>Other</b>			
Operation Manual in the manuals compartment	10	10	10
All decals/labels complete, clear and secure	10	10	10
Annual inspection date of the machine	/	/	10
No unapproved changes or additions	10	10	10
All safety publications taken into account	10	10	10
General structural components and weldments	2	2	2
All fasteners, pins, protective guards and covers	1, 2	1, 2	1, 2
Greasing and lubricating according to specifications	10	10	10
Functional test of all systems	10	10	10
Paint and appearance	5	5	5
Inspection date stamped on the chassis	/	/	10
Notify Sinoboom of machine ownership (change)	/	/	10

**Table 10-9 Inspection and Preventive Maintenance Schedule (continued)**

Item	Interval		
	Before each delivery <sup>1</sup> or quarterly <sup>2</sup>	Semiannually <sup>3</sup>	Annually <sup>4</sup>
<p>Note:</p> <p><sup>1</sup> Before each sale, lease or shipment delivery;</p> <p><sup>2</sup> In service for 3 months or 250 hours; or out of service for more than 3 months;</p> <p><sup>3</sup> In service for 6 months or 500 hours;</p> <p><sup>4</sup> Once a year and no later than 13 months from the date of the previous annual machine inspection;</p> <p><sup>50</sup> The first inspection shall be performed once the machine reaches 50 hours in service for the first time. This occurs only once in the service life of the machine.</p> <p><sup>250</sup> The first inspection shall be performed once the machine reaches 250 hours in service for the first time. This occurs only once in the service life of the machine.</p> <p>NO.1 Before the machine is put into service for the first time, or before the first use after the oscillating cylinder or counterbalance valve has been replaced.</p>			
<p>Inspection activity (numerical codes):</p> <ol style="list-style-type: none"> <li>1. Check for correct installation (accurate position, firmly installed, tightened to the specified torque)</li> <li>2. Check for damage (cracks, cracked welds, deformation, wear, corrosion, excessive wear, gouges, abrasions and exposed threads)</li> <li>3. Check for normal function</li> <li>4. Return to neutral position or "off" position normally (the self-reset switch can return to neutral position or "off" position after released)</li> <li>5. Clean and free of foreign objects</li> <li>6. Check for correct level, sealing and leaks</li> <li>7. Labels complete, clear and secure</li> <li>8. Check for appropriate tolerances</li> <li>9. Fully charged</li> <li>10. Verify/perform</li> <li>11. Replace the oil or filter element</li> <li>12. Correctly lubricated</li> </ol>			

# DECLARATION OF CONFORMITY

Machinery Directive: 2006/42/EC  
Electromagnetic Compatibility Directive:  
2014/30/EU

**Name of manufacturer or supplier**

Hunan Sinoboom Intelligent Equipment Co., Ltd.

**Full postal address including country of origin**

No.128, East Jinzhou Avenue, Ningxiang High-tech Industrial Park, Changsha, Hunan, China

**Authorized Representative**

Sinoboom B.V.  
Nikkelstraat 26, NL-2984 AM Ridderkerk, The Netherlands

**Description of product**

Mobile Elevating Working Platform

**Name, type or model, batch or serial number**

Name: Mobile Elevating Working Platform

**Standards used, including number, title, issue date and other relative documents**

EN 60204-1:2018/Safety of machinery - Electrical equipment of machines - General requirements  
EN 280-1:2022 / Mobile elevating work platforms - Design calculations - Stability criteria - Construction - Safety - Examinations and tests

**Declaration**

I declare that as the authorised representative, the above information in relation to the manufacture of this product, is in conformity with the stated standards and other related documents following the provisions of the above Directives and their amendments.

**Signature of manufacturer**



# Always for Better Access Solutions



## Hunan Sinoboom Intelligent Equipment Co., Ltd.

No.128, East Jinzhou Avenue, Ningxiang High-tech Industrial Park, Changsha, Hunan, China

☎ 0086-0731-87116222 (Sales) & 0086-0731-87116333 (Service)

✉ sales@sinoboom.com

🌐 www.sinoboom.com

### North American Subsidiary

Sinoboom North America LLC

105 W Riley Rd, Houston, TX,  
77047, US

E-mail: sales@sinoboom.us

Phone: +1 (800)867-2552

### Australia Subsidiary

Sinoboom Intelligent Equipment Pty Ltd.

32-34 Marni St, Dandenong South, Vic  
3175

E-mail: au@sinoboom.com

Phone: +61 484 118 324

### Korea Subsidiary

Sinoboom Korea Co., Ltd.

E-mail: sales@sinoboom.com

Phone: +82-10-2533-1831

### Europe Subsidiary

Sinoboom B.V.

Nikkelstraat 26  
NL-2984 AM Ridderkerk  
The Netherlands

E-mail: info@sinoboom.eu

Phone: +31 180 225 666

### Brazil Subsidiary

SINOBOOM Brasil LTDA

Av. Antonieta Piva Barranqueiros,  
62 – Unidade 1 - Distrito Industrial, Jundiaí  
- SP Brazil

E-mail: sales@sinoboom.com

### Mexican Subsidiary

SINOBOOM LATIN AMERICA, S. DE R. L.  
DE C. V.

Camino a Napoles Km. 2+370(LI)  
entronque a brecha Km.1(LI) del Ejido San  
Miguel del Arenal, Silao de la Victoria, Gto.

### Poland Subsidiary

Sinoboom Poland Sp.z o.o.

Ul. Boleslawa Krzewoustego 74A,  
61-144 Poznan. Poland

E-mail: sales@sinoboom.com

### Middle East Subsidiary

Sinoboom Middle East FZE

Q4-085 , SAIF-Zone,  
Sharjah, U.A.E.

E-mail: sales@sinoboom.com