









KENMERKEN / FEATURES / MARKMALE







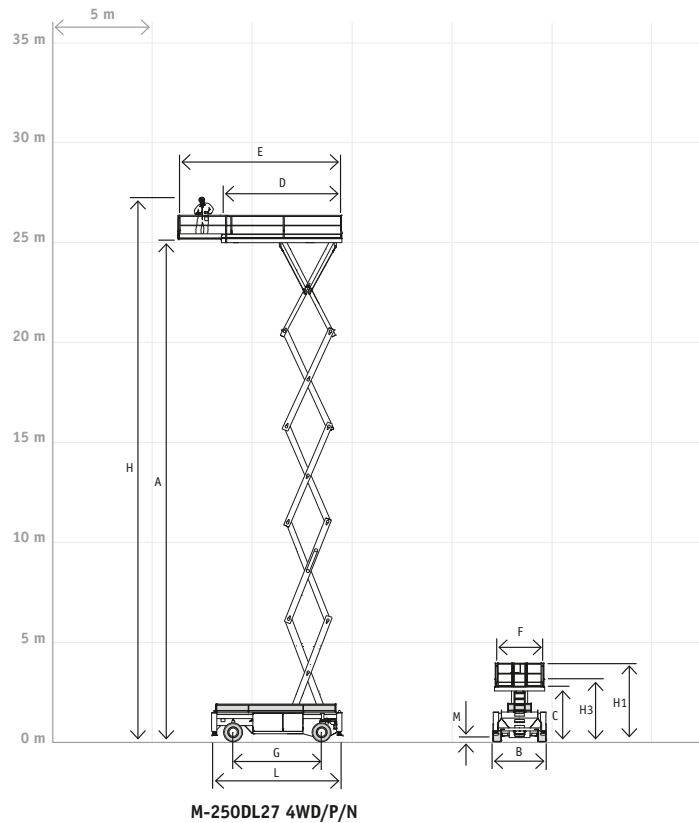





	M-250DL27 4WD/P/N
H (max.)	± 27,00 m
A (max.)	± 25,00 m
C (min.)	± 2,75 m
DxF (min.)	6,15 x 2,50 m
ExF (max.)	8,25 x 2,50 m
H1	3,89 m
H3	3,13 m
LxB	6,57 x 2,65 m
G	4,50 m
M	195 mm
∅ D	± 7,65 m
 (max.)	1000 kg (4 pers. + 680kg)
 (max.)	1000 kg (4 pers. + 680kg)
 (sec.)	120/105 sec.
	4,2 km/h
	0,5 km/h
	15 x 19,5
 (max.)	± 30%
	Deutz BF4L20011
	21.910 kg



NETERLANDS	ENGLISH	DEUTSCH	
OPTIES	OPTIONS	OPTIONEN	
Besturing met snelsluitstekker	Controlbox with quick disconnect	Plattformsteuerung mit Schnellstecker	●
Urenteller	Hourmeter	Stundenzähler	●
230V voorziening op het platform	230V supply on the platform	230V Versorgung an der Plattform	○
Generator 230V	Generator 230V	Generator 230V	○
Rijden op volle hoogte	Driving at full height	Fahren in voller Höhe	○
Rijden, proportioneel	Driving, proportional	Fahren, proportional	●
Sperfunctie	Differential lock	Differentialsperre	●
Vierwiel aandrijving (4WD)	Fourwheel drive (4WD)	Allradantrieb (4WD)	●
Pendelas (P)	Oscillating axle (P)	Pendelachse (P)	●
Nivelleerstempels (N)	Levelling jacks (N)	Nivellierstützen (N)	●
Smeersysteem (Easy Lube, Auto Lube)	Lubrication system (Easy Lube, Auto Lube)	Schmiersystem (Easy Lube, Auto Lube)	○
VEILIGHEIDSVORZIENINGEN	SAFETY FEATURES	SICHERHEITSEINRICHTUNGEN	
Beschermhek	Scissor skirt	Schutzgitter	●
Rij-alarm (akoestisch)	Drive alarm	Fahrwarnung (akustisch)	●
Nooddaalvoorziening	Emergency descent	Notsenkvorrichtung	●
TOEPASSING	APPLICATION	ANWENDUNG	
Voor gebruik in gesloten ruimten	Indoors	In geschlossenen Räumen	●
Voor gebruik buiten	Outdoors	Im Freien	●
Toelaatbare min. omgevingstemperatuur	Certified min. temperature	Zul. Tiefsttemperatur	-15°C



NOTITIES / NOTES / NOTIZEN

H (max.)	Werkhoogte Working height Arbeitshöhe
A (max.)	Max. platformhoogte Max. platform height Max. Plattformhöhe
C (min.)	Min. platformhoogte Min. platform height Min. Plattformhöhe
DxF (min.)	Platform afmetingen (ingeschoven) Platform dimensions (retracted) Plattformgröße (eingeschoben)
ExF (max.)	Platform afmetingen (uitgeschoven) Platform dimensions (extended) Plattformgröße (ausgeschoben)
H1	Transporthoogte Transport height Transporthöhe
H2	Transporthoogte (handrail verwijderd) Transport height (handrail removed) Transporthöhe (Geländer entfernt)
H3	Transporthoogte (handrail neergeklapt) Transport height (handrail folded down) Transporthöhe (Geländer umgeklappt)
LxB	Transportafmetingen Transport dimensions Transportabmessungen
G	Wielbasis Wheel base Radstand
K	Trackbreedte Track width Raupenbreite
M/N	Bodemvrijheid Ground clearance Bodenfreiheit
∅ D	Draaicirkel uitwendig Turning radius outside Wenderadius Außen
 (max.)	Max. belasting platform (ingeschoven) Capacity main-platform Tragfähigkeit Plattformfestteil
 (max.)	Max. belasting platform (uitgeschoven) Capacity roll-out deck Tragfähigkeit Platformausschub
 (sec.)	Hef-/daaltijd (max. last) Lift-/lower time (max. load) Hebe-/Senkzeit (max. Traglast)
	Rijsnelheid (snel) Driving speed (high) Fahrgeschwindigkeit (schnell)
	Rijsnelheid (langzaam) Driving speed (slow) Fahrgeschwindigkeit (langsam)
	Banden, non marking (volrubber) Tyres, non marking (solid rubber) Reifen, non marking (Vollgummi)
	Banden, terrein (schuimgevuld) Tyres, terrain (foamfilled) Reifen, Gelände (ausgeschäumt)
	Banden, tractor (schuimgevuld) Tyres, tractor (foamfilled) Reifen, Traktor (ausgeschäumt)
	Vlakstellen links/rechts (dwars) Levelling left/right (transversal) Quernivellement (links/rechts)
 (max.)	Max. klimvermogen Gradeability Max. Steigfähigkeit
	Batterijcapaciteit (natte cellen) Batteries (traction acid) Batteriekapazität (Traktion Naßzellen)
	Dieselmotor Diesel engine Dieselmotor
 KG	Eigengewicht Gross weight Eigengewicht
●	Standaard Standard Standardausrüstung
○	Optie Option Option
--	Niet beschikbaar Not available Nicht verfügbar

V36

